



EpilogLaser

GalvoG100

Laser System Manual | Model 18000

Original Instructions



Register your system now for driver updates and access to our Training Suite!

[TRAINING.EPILOGLASER.COM/REGISTER](https://training.epiloglaser.com/register)

Technical Support: +1 (303) 215-9171

Knowledge Base: support.epiloglaser.com

System Registration: training.epiloglaser.com/register

Driver/Firmware: epiloglaser.com/tech-support/fusion-galvo-drivers/

TABLE OF CONTENTS

FIRE WARNING	1
INTRODUCTION	2
How to Use This Owner's Manual	2
Icons Used in this Manual.....	2
Intended Use	4
SECTION 1: SAFETY	7
Laser Safety	7
Electrical Safety.....	8
Safety Features and Regulatory Compliance.....	9
Do and Don't.....	13
Care Instructions.....	14
Lifting Instructions.....	14
SECTION 2: GETTING STARTED	15
1. Choose Where to Locate the System	16
2. Connecting the Exhaust.....	17
3. Connecting Electrical Power	19
4. Connecting the Laser to Your Computer	19
5. Power on the Laser	20
6. Set the Fusion Galvo's IP Address	22
7. Install the Software Suite & Set Up Your Laser.....	25
8. Sign Up for Driver Updates and Register Your System	26
SECTION 3: SOFTWARE INSTALLATION	27
Epilog Software Suite Instructions.....	27
Uninstalling the Previous Job Manager.....	27
How to Install the Epilog Software Suite.....	29
Windows 8/10: Ethernet Installation	35
Windows 8/10: USB Installation	37
Troubleshooting the Job Manager.....	37
Important Job Manager Notes	38
SECTION 4: THE JOB MANAGER	39
Using the Epilog Job Manager	39
Printing to the Epilog Job Manager	42
Organizing Your Print Jobs	43
Previewing Your Job	46
Searching for a Job	47
Finding Job History	47
Vector Sorting.....	48
Material Settings Tab.....	49
Job Settings Tab	53
Using the Material Setting Configurations.....	55
Changing Program Settings.....	57
Troubleshooting the Job Manager.....	59
SECTION 5: THE LASER DASHBOARD	61
Setting Up CorelDRAW for the Laser.....	62
Sending Your First Project.....	63
Setting Up Adobe Illustrator for the Laser.....	67
Dashboard Settings	69
Presetting Your Vector Lines.....	71
Placing Your Artwork	72

TABLE OF CONTENTS

Dividing Your Job Into Processes.....	73
Editing Artwork with Live View.....	77
Saving Your Settings.....	80
File Settings.....	81
Settings in Detail.....	82
Guidelines.....	83
Processes Tab.....	86
Advanced Tab.....	87
Notes Tab.....	87
Additional CorelDRAW Laser Dashboard Features.....	88
SECTION 6: CONTROL PANEL	89
Display.....	89
Job Storage.....	97
SECTION 7: QUICK START GUIDE	99
Artwork Setup.....	99
Setting a Vector Marking Line.....	99
Resolution.....	100
SECTION 8: SYSTEM FEATURES	103
IRIS™ Camera Positioning System.....	103
Touch Screen.....	103
Exhaust.....	104
Auto Focus vs Manual Focus.....	104
Red Dot Pointer.....	105
Job Trace.....	105
Emergency Stop.....	106
Door Handles.....	106
Calibration Mat.....	107
SECTION 9: OPTIONAL FEATURES	109
Fusion Galvo G100 Rotary Setup.....	109
Fusion Galvo 3 Jaw Chuck Rotary Attachment.....	111
SECTION 10: UPGRADING FIRMWARE	121
How to Upgrade Your Firmware.....	121
SECTION 11: ENGRAVING MATERIALS	127
Fiber Laser Materials/Techniques.....	127
SECTION 12: SPECIFICATIONS	131
Fusion Galvo Laser Technical Specifications.....	131
SECTION 13: TECHNICAL SUPPORT	133
Contacting Technical Support.....	133
Join Epilog Laser's Online Community.....	134
APPENDIX A: WARRANTY STATEMENT	135
Warranty Statement for the Fusion Galvo Laser.....	135
APPENDIX B: MATERIAL SETTINGS	137
Fusion Galvo Suggested Material Settings (F163 Lens).....	137
Fusion Galvo Suggested Material Settings (F254 Lens).....	142

TABLE OF CONTENTS

APPENDIX C: SYSTEM MAINTENANCE	147
Calibrating the Auto Focus.....	147
Camera Calibration.....	149
INDEX	155

FIRE WARNING

Fire Warning



Your laser system uses a high intensity beam of light that can generate extremely high temperatures when it comes into contact with the material being engraved, marked or cut. Some materials are extremely flammable and can easily ignite and burst into open flame setting the machine afire. This open flame is very dangerous and has the potential to destroy not only the machine, but the building in which it is housed.

Please read the following warnings and recommendations and follow them closely at all times!

- **Stay with the laser.** Never operate the laser system while unattended.
- **Keep the area clear.** Clean around the machine and keep the area free of clutter, combustible materials, explosives, or volatile solvents such as acetone, alcohol, or gasoline.
- **Be prepared with a fire extinguisher.** Always keep a properly maintained and inspected fire extinguisher on hand. Epilog recommends a Halotron fire extinguisher or a multi-purpose dry chemical fire extinguisher.
- **Clean the laser.** A buildup of cutting and engraving residue and debris is dangerous and can create a fire hazard in its own right. Keep your laser system clean and free of debris.

INTRODUCTION

How to Use This Owner's Manual

Thank you for purchasing an Epilog Fusion Edge Laser system. Your Epilog system has been designed to be easy to operate, but you will utilize it to its fullest potential by taking some time to read this owner's manual prior to use. You will be ready to use the Epilog Laser system as soon as you read the first few sections. Then you can refer to topics in the remaining sections, as you work.

Icons Used in this Manual

Look for these symbols to help you find valuable information throughout the text:



Helpful notes to keep in mind when running the laser!



This icon signifies advice you can try that will save you significant time.



This icon highlights current contact information for receiving help.



Warnings and cautions to keep in mind when running the laser.



This icon indicates the potential for fire damage when operating the laser.

INTRODUCTION



Manufacturer:

Epilog Laser
16371 Table Mountain Parkway
Golden, CO 80403
Phone: +303-277-1188
www.epiloglaser.com

Authorized Representative:

Certification Experts
Amerlandseweg 7
3621 ZC,
Breukelen, The Netherlands

INTRODUCTION

Intended Use

The model 18000 Epilog Fusion G100 galvo laser system is intended to be used for engraving and marking coated and bare metals. Some plastics can also be engraved or marked.

The operator of the Epilog Model 18000 should be trained by an authorized Epilog representative before operating the laser system. The operator of the Epilog Model 18000 should observe all instructions in the owner's manual. The following general precautions should be taken:

Do

Keep the G100 clean. Spend a few minutes on a regular basis to keep the machine free of dust dirt buildup.

Don't

- **Do Not Run the Laser Unvented:** Never operate the machine without a properly operating vent to the outside or to a filtration unit! Most material will only produce an irritating dust when engraved. Some materials, including but not limited to paint, varnish, composition board and plastics, produce compounds that can be harmful if concentrated. A properly installed vent is the only way to ensure that problems do not occur.
- **Do Not Engrave or Cut PVC:** Never process any material containing PVC or vinyl. When processed, a corrosive agent is produced that will destroy your machine. Your warranty will be void if your machine is damaged by corrosion from processing PVC or Vinyl.
- **Do Not Operate Machine While Unattended:** Never operate your machine without someone watching the system.
- **Do Not Operate The System While Doors are Open:** Never operate the equipment with any of the covers or enclosures removed. Never modify the enclosure. The laser beam is invisible and is very dangerous.

General Description of Machinery

The Epilog Model 18000 Fusion G100 is a PC based, computer-controlled, high-speed fiber laser system. It is designed to mark and engrave on coated or bare metals, and some plastics using a Ytterbium fiber laser source. The fiber laser produces an invisible beam of light with a wavelength of approximately 1,064 nm. The laser light reacts thermally with the material being processed to leave a contrasting mark on the metal or plastic.

The G100 uses mirrors mounted to galvanometers to steer the laser beam from the laser source to the work surface of the metal or plastic.

INTRODUCTION

Workstation

The workstation needs to be a Windows based computer operating almost any software that has a printing function. Most users use Adobe Illustrator, CorelDraw or similar graphics or design software.

Residual Risks

The Fusion model 18000 G100 is a Class 2 laser system. The laser beam is fully enclosed in a cabinet and is not humanly accessible during normal operation. Double redundant interlocks prevent the laser from firing when the front door is open. All other access panels need a tool to remove them. Do not remove access panels or operate the laser system if the access panels have been removed.

A Class 2 laser system has a red dot pointer that is humanly accessible with the doors open. Do not stare into the red dot pointer.

Personal protective gear (eyewear) is not required when operating the G100 laser system with all access panels in place and the front door closed.

Accident or Breakdown

In case of accident or breakdown, contact Epilog Laser or your local Epilog representative for repair. Do not disassemble or otherwise modify the G100 laser system.

Spare Parts

In the case of accident or breakdown, contact Epilog Laser or your local Epilog representative for repair. Only Epilog Laser factory parts should be used to repair your laser system. The use of third party parts or components will void your warranty.

Disposal

The Fusion G100 galvo is recyclable. Do not dispose of the machine in the trash. Electronic components should be disposed of in accordance with regional directives. Contact your Epilog representative for disposal instructions.

Protective Grounding

Notice: Only connect the Fusion G100 to a power source having a three-wire grounded outlet.

SECTION 1: SAFETY

Laser Safety

The Epilog Model 18000 Laser System is a Class 2 laser product, as defined in International Standard IEC 60825-1.

The Epilog Model 18000 complies with 21 CFR 1040.10 and 1040.11, the Federal Performance Standards for Light-Emitting Products, except for deviations pursuant to Laser Notice No. 50, dated July 16, 2001. The Center for Devices and Radiological Health, of the US FDA, issued Laser Notice No. 50 to permit manufacturers to classify and manufacture their products in accordance with the International Standard.

The output of the embedded laser is fully contained. The laser cabinet has safety interlocks that turn the laser off if any access door is opened during operation, and no special precautions are necessary to operate the laser safely. Access doors are interlocked and can be opened without the use of a tool. Any interlocked door that is opened while the machine is operating will immediately stop the laser from firing.

Access panels are not interlocked and require a tool for opening or removal. Access panels should always be installed when the laser is operating. Never operate the laser system with an access panel removed.

The visible output beam of the Laser Diode Pointer (Red Dot Pointer) is accessible to the operator. While this device employs the same technology as the familiar laser pen-pointers, like them it is potentially hazardous if its beam is directed into the eye.

We have made every effort to make the Laser Diode Pointer (Red Dot Pointer) as safe as possible. Its beam path is located well inside the cabinet, and under normal conditions, no hazardous levels of laser radiation can escape.

The operator of the Epilog Model 18000 should observe the following general precautions:



DO NOT disassemble the machine or remove any of its protective covers while the unit is plugged in.

DO NOT attempt to defeat the door interlocks.

DO NOT view directly into the beam of the Laser Diode Pointer (Red Dot Pointer).

DO NOT operate the Laser Diode Pointer (Red Dot Pointer) without the machine's focus lens in place. If the unfocused beam strikes a reflective surface, it could be directed out of the cabinet.

Caution – Use of controls or adjustments or performance of procedures other than those specified herein may result in hazardous radiation exposure.

SECTION 1: SAFETY

The standard reference for laser safety is the American Standard for the Safe Use of Lasers, Z136.1-2000, developed by the American National Standards Institute (ANSI). This reference is the basis for many of the federal regulations for laser and laser system manufacturers, and for the Occupational Safety and Health Administration (OSHA) laser safety guidelines. It contains detailed information concerning proper installation and use of laser systems.

While the ANSI standard itself does not have the force of law, its recommendations, including warning signage, training, and the designation of a laser safety officer, may be compulsory under local workplace regulations when operating laser systems above Class I. It is the operator's responsibility to ensure that the installation and operation of the Epilog Model 18000 Laser System is performed in accordance with all applicable laws.

Copies of ANSI Standard Z136.1-2000 are available from Epilog Corporation or from:



Laser Institute of America
12424 Research Parkway, Suite 125
Orlando, FL 32826
(407) 380-1553

Electrical Safety

The AC input power to the Epilog Model 18000 Laser System is potentially lethal and is fully contained within the cabinet.



- **DO NOT** open any of the machine's access panels while the unit is plugged in. Opening a panel may expose the operator to the unit's AC input power.
- **DO NOT** make or break any electrical connections to the system while the unit is turned on.

Fusion Galvo G100 Electrical Specifications

Model	Wattage(s)	Voltage	Amp draw-MAX
Galvo G100	30, 30 MOPA, 60 MOPA	100-120	13A
Galvo G100	30, 30 MOPA, 60 MOPA	220-240	6.5A

SECTION 1: SAFETY

Safety Features and Regulatory Compliance

Epilog has incorporated specific safety features into the Model 18000 Laser System in order to meet the requirements of 21 CFR 1040 and the International Standard IEC 60825-1. These safety features include:

- A safety enclosure (cabinet), which fully encloses the engraving laser and its beam path.
- Dual redundant interlock systems that turn off the engraving laser when the window is opened.
- A visible emission indication when the Laser Diode Pointer (Red Dot Pointer) is operating. There is an LED indicator on the machine's front panel.

21 CFR 1040 and IEC 60825-1 require that certification, identification, and warning labels be placed on laser products. Reproductions of labels on the Epilog Model 18000 Laser System follow, with their locations specified:

1. **Certification/Identification Plate:** This engraved plate is located on the back of the machine.

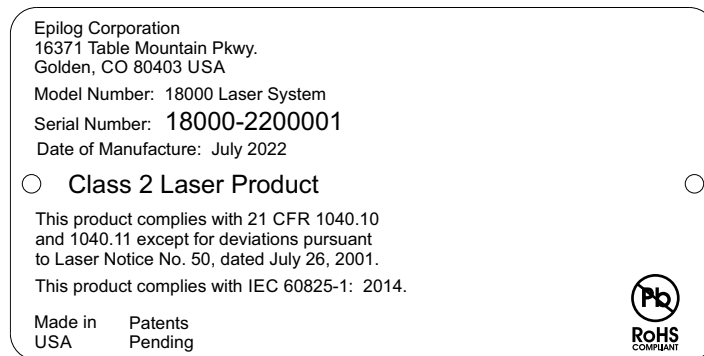

2. **Warning Logotype:** This label is located on the back of the machine, to the right of the Certification/Identification plate.



SECTION 1: SAFETY



3. **Descriptive Label:** This label identifies the classification of the Model 18000 in accordance with 21 CFR 1040.10 and IEC 60825-1. It is located on the back of the machine, next to the Warning Logotype.



4. **Non-interlocked Protective Housing Safety Labels:** These labels are located on, or adjacent to, removable access covers on the machine's cabinet as shown in the diagrams to follow. Where a label is located on a removable cover, there is an additional label under the cover so that it will be visible when the cover has been removed.



5. **Defeatably-interlocked Protective Housing Safety Labels:** There is one label on the machine's top door.

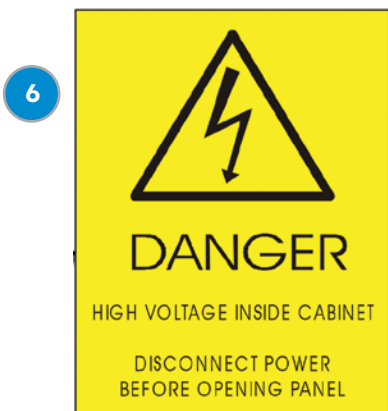

6. **Electrical Safety Label:** This label is located on the back of the machine in the lower left-hand corner.

7. **Main Breaker Label:** This label is located on the power module panel at the right side of the machine's cabinet.

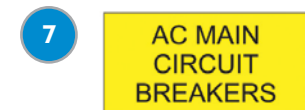

8. **Mechanical Safety Label:** This label is located on top of the cabinet door.

9. **Consult Manual Label:** This label is located on top of the cabinet door.

10. **Aperture Safety Label:** This label is located above the aperture, inside the cabinet, where laser beams enter the machine's engraving area.

11. **Power Labels:** The appropriate label for the machine is located on the power module panel at the right side of the machine's cabinet.

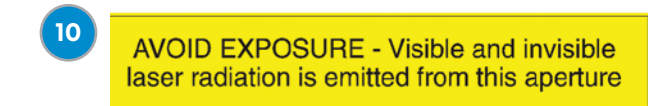

SECTION 1: SAFETY

The following diagrams show the location of each specific label.

Fusion Galvo G100:

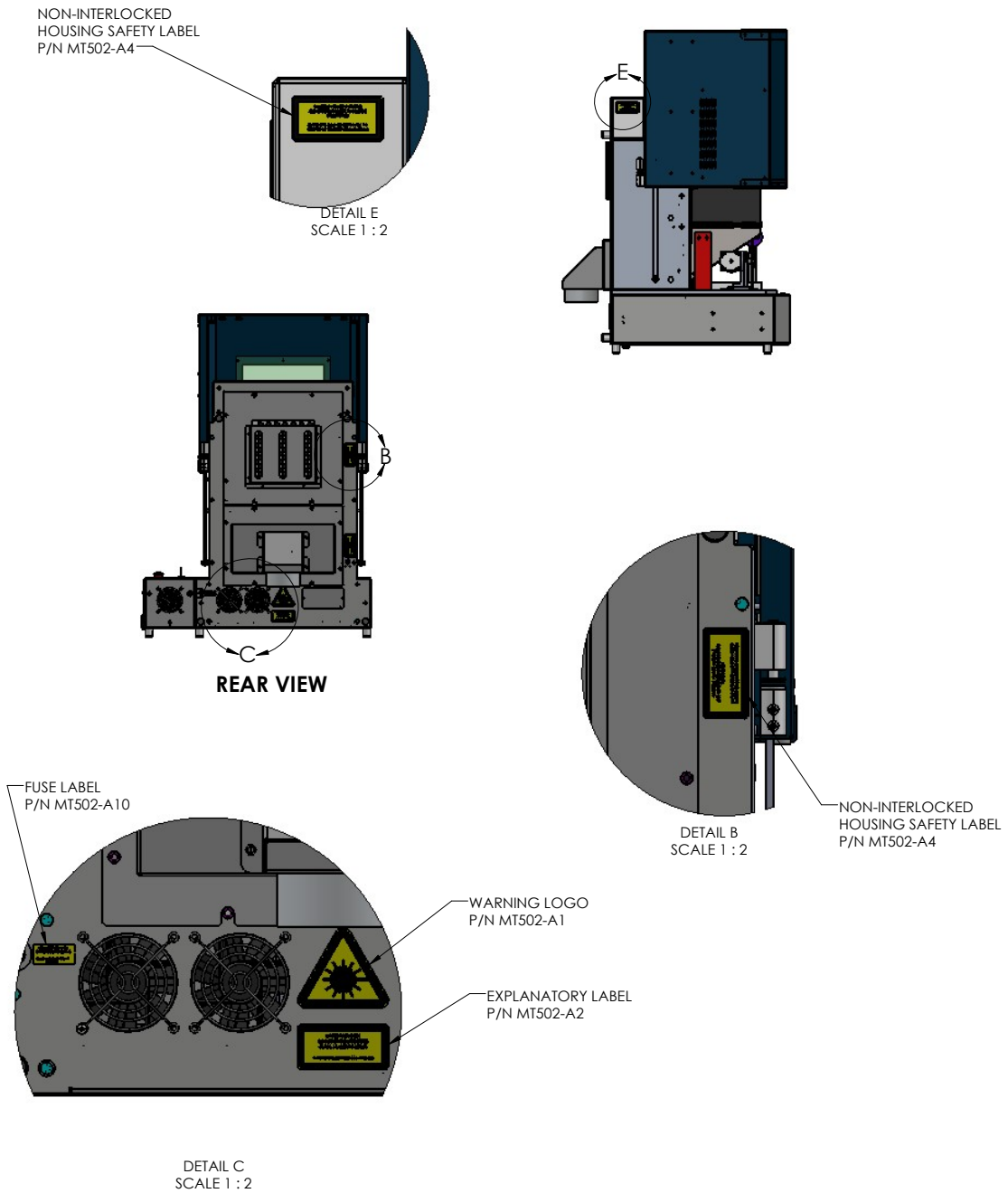

SECTION 1: SAFETY

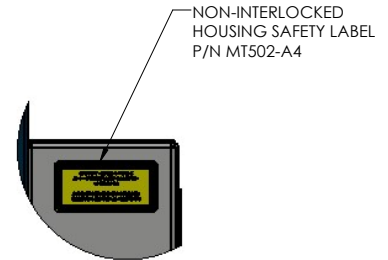
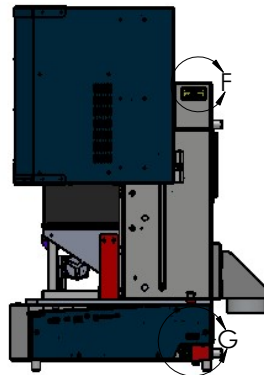
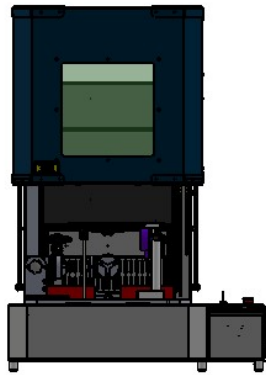

DETAIL F
SCALE 1 : 2

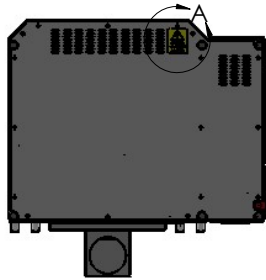

DETAIL A
SCALE 1 : 2

POWER LABEL
P/N MT502-A7

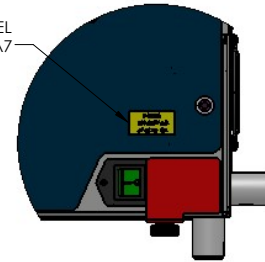

DETAIL G
SCALE 1 : 2

ELECTRICAL SAFETY LABEL
P/N MT502-A5

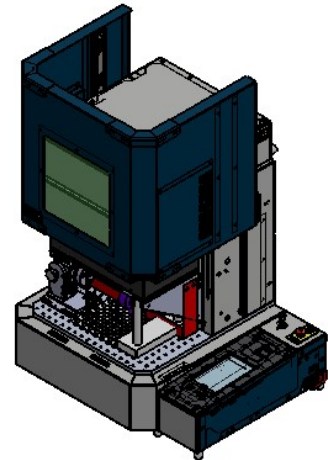

EPILOG LASER CORPORATION
MODEL 18000
SAFETY LABEL DRAWING

DRAWING NO.



Epilog Laser
16371 Table Mountain Pkwy
Golden, CO 80403-1826
P 303.277.1188 F 303.277.9669
www.epiloglaser.com

DRAWING NAME SAFETY LABEL DRAWING

FILENAME GC0030 Assy, Top, G3, Safety Label Drawing

DRAWN *John Ellis*

DATE 01/06/23

REV

SHEET 1 OF 1

SECTION 1: SAFETY

Do and Don't



Don't

Do Not Run the Laser Unvented: Never operate the machine without a properly operating vent to the outside or to a filtration unit! Most material will only produce an irritating smoke when engraved. Some materials, including but not limited to paint, varnish, composition board and plastics, produce compounds that can be harmful if concentrated. A properly installed vent is the only way to ensure that problems do not occur.

Do Not Engrave or Cut PVC: Never engrave or cut **any material** containing PVC or vinyl. When engraved, a corrosive agent is produced that will destroy your machine. Your warranty will be void if your machine is damaged by corrosion from engraving or cutting PVC or Vinyl.

Do Not Operate Machine While Unattended: Never operate your machine without someone watching the system. There is a significant risk of fire if the machine is set improperly, or if the machine should experience a mechanical or electrical failure while operating.

Do Not Operate The System While Doors are Open: Never operate with any of the covers or enclosures removed, and never modify the enclosure. The laser beam is invisible and is very dangerous!



Do

Clean the System: Please allow a few minutes a week for cleaning your machine. Just a small amount of effort at the end of the week will pay off with years of trouble-free operation of your machine.

SECTION 1: SAFETY

Care Instructions

- **Operating altitude** – 3,500 meters max
- **Relative Humidity** – 100% max, non-condensing
- **Disposal** – The Galvo G100 is recyclable. Do not dispose of the machine in the trash. Electronic components should be disposed of in accordance with regional directives.
- **Protective Grounding** – Notice: Only connect the Galvo to a power source having a three-wire grounded outlet.



Note: The Fusion Galvo G100 is not suitable for wet locations or pollution degree greater than 2.

Lifting Instructions

Galvo G100

The Fusion Galvo G100 laser system can be lifted and carried using two or more people on the sides of the machine.

SECTION 2: GETTING STARTED

Setting up your Epilog Laser System is easy to do! If you've ever installed a paper printer, this is only slightly more difficult. The following information will help you understand the entire system and how it works.

Your Fusion Galvo laser system consists of the following components:

1. Fusion Galvo Laser System
2. Epilog USB thumb drive with Software Suite installation files
3. USB and Ethernet Cables
4. Two keys for the Keyswitch
5. 4" (102mm) exhaust port
6. Power Cables
7. Thumb screws
8. 254 F-Theta Lens

You will also need:

1. A computer or laptop.
2. An exhaust fan: The exhaust fan is mandatory and is used to remove smoke and debris from the Fusion Galvo work area. The exhaust air can be ported to the outside or into a filter box.

Follow these steps to set up your Fusion Galvo Laser system after unpacking it:

1. Choose where to locate the system.
2. Connect the exhaust port to the back of your laser.
3. Connect the exhaust fan or filter to the laser.
4. Connect the electrical power.
5. Insert Key into Keyswitch
6. Connect the laser to your computer.
7. Power on the laser and select your settings in the unboxing wizard.
8. Sign up for driver updates and register your system at www.epiloglaser.com/register.



Note: Both the Power switch and the Keyswitch must be in the “On” position for the G100 to power on.

SECTION 2: GETTING STARTED

1. Choose Where to Locate the System

Cooling Requirements and Operating Temperatures

All Epilog Laser systems use air-cooled laser tubes. Laser technology is such that the laser tubes generate a lot of excess heat and the tubes must be cooled for proper operation. There are cooling fans located on both sides of the laser. The fans and vents should always be clear of restrictions and should never be covered.



Warning: The cooling fans and vents are located on both sides of the Fusion Galvo and should never be covered or blocked in any way. Lasers that overheat will not operate properly and may begin to produce erratic laser output or possibly complete failure.

Ambient air temperature where the laser system is operating should not exceed 90 degrees F (32 C). Operating in an environment where the ambient air temperature is above 90 degrees F (32 C) will void the Epilog warranty. **For more information, see the “Warranty Statement for the Fusion Galvo Laser” on page 135.**

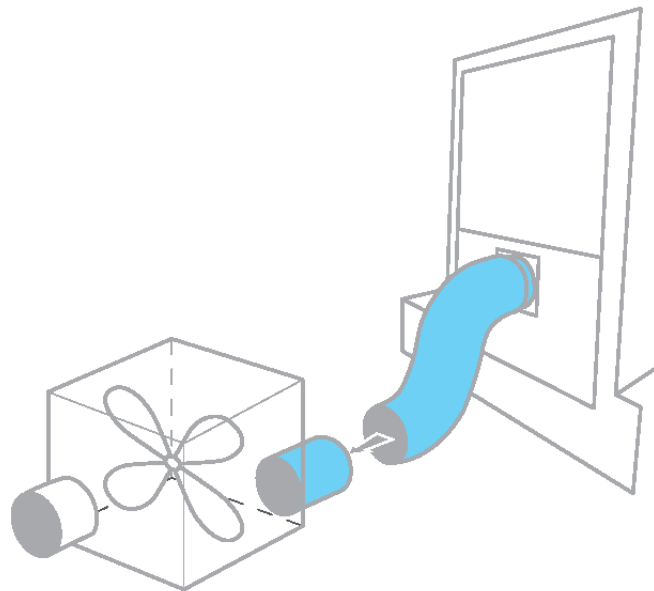

SECTION 2: GETTING STARTED

2. Connecting the Exhaust

In this manual, the term “exhaust” refers to either an exhaust fan or a filter unit and the term “exhaust” is used for simplicity. The important point is that it is mandatory that an exhaust unit or filter system is incorporated as part of your laser system. Never operate your laser system without a properly functioning exhaust. The exhaust removes the dust, debris and smell from the engraving cavity and exhausts it to the outside of the building or to the filter unit. Prior to the installation of the laser system, you may need a contractor to install the exhaust system. The blower should be mounted outside your building for noise considerations. Ideally, the blower should not be more than twenty feet (6 meters) from the laser. You should provide a metal duct (flexible aluminum or galvanized sheet metal) from the blower to the laser. All Epilog model 18000 laser systems require an exhaust fan that is rated at a minimum of 450 CFM for external exhaust.

Epilog provides recommended exhaust flow rates (CFM) only for direct ventilation exhaust systems that are ported to the outside. Please note that this is also a recommendation and not a requirement, because factors such as length and type of tubing from the Epilog laser to the exhaust fan and from the exhaust fan to the outside of the building can produce significant losses on the true amount of air that is drawn from the Epilog laser.

Exhaust flow rates (CFM) for filter systems are not specified in this document. However, exhaust flow rates for filtration units will be lower than a direct ventilation exhaust system because filters are designed to be placed directly adjacent to the laser system and do not exhibit the air-flow losses that are typically found with direct exhaust fans. Epilog has worked with most major filter manufacturers to recommend a specific filter system for each model of Epilog laser. Please contact your Epilog distributor to match a filter to the Epilog laser system you are using.



Note: Remember to put the blower switch for the laser system in an obvious and accessible place so it can be routinely switched on prior to using the engraver. Please connect the exhaust blower to the laser as shown below and on the following pages.

Remember, you may need a contractor to install the exhaust. This must be done PRIOR to installation of the laser system.



Warning: It's important that either rigid or flexible metal ducting be used for all connections leading to and from the laser system and the exhaust fan. Vinyl, plastic, or any type of “soft” ducting is potentially flammable and should not be used unless provided by the filtration system manufacturer and made from fire-proof materials.

SECTION 2: GETTING STARTED

Epilog Exhaust/Filter Connections

There is one 4" (102 mm) port attached to the back of the Fusion Galvo laser system. The exhaust port on the Fusion Galvo is approximately 17 inches (431.8 mm) from the top of the machine. Attach your ducting to the machine as shown in the diagram.

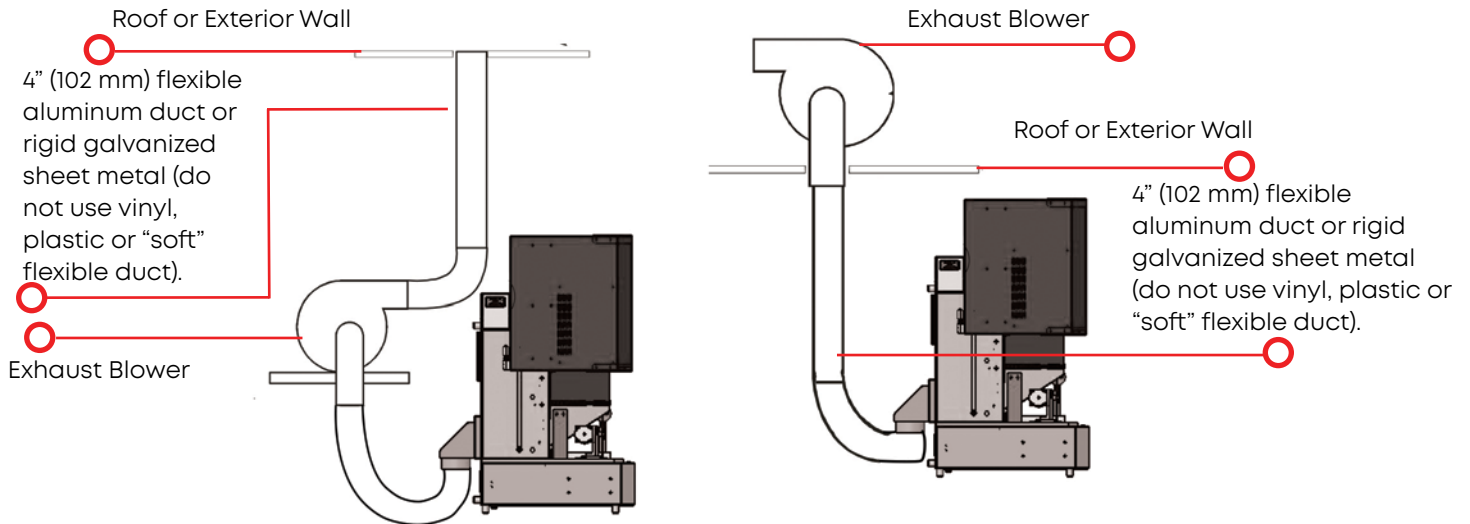

Check your exhaust system for leaks. Most small leaks can be remedied with duct tape. **DO NOT OPERATE** your laser with inadequate or leaking exhaust.

The drawings above show the typical exhaust setup. The left drawing shows the exhaust near the machine and the right drawing shows the exhaust fan on the roof. Where the exhaust fan is placed is a choice of personal preference. Some users like the exhaust fan outside because of noise considerations.

SECTION 2: GETTING STARTED

3. Connecting Electrical Power

Epilog supplies the appropriate power cord for the system you ordered. The power cord is found in the accessory package with your machine. The power cord for the laser plugs into the power receptacle located on the right side of the machine in the rear corner. It is recommended that a dedicated 15-amp circuit be used if available, but it is not required. The Fusion Galvo laser system requires 100-240-volt electrical power.

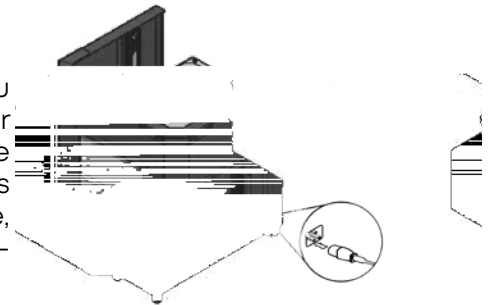

Electrical Connection
120-240 V-50/60 Hz

4. Connecting the Laser to Your Computer

You are now ready to connect your computer to the laser. The following connections can be used:

1. **USB only connection:** You can use the USB port for connecting to the Software Suite, however, multiple laser systems cannot be operated from a single computer through a USB connection.
2. **Ethernet only connection:** With an Ethernet connection you can print from the Software Suite to multiple machines at once.
3. **Wireless connection:** To connect to the laser via wireless connection, boot up the laser and follow the instructions “**5. Power on the Laser**” on page 20.

USB Connection

A USB cable is included in the accessory kit. The USB port is located on the right-hand side of the machine. USB cables have different connectors on each end. The USB connection will behave similarly to an Ethernet cable when communicating with the laser. Both the computer and machine should recognize the USB without any need to reboot.

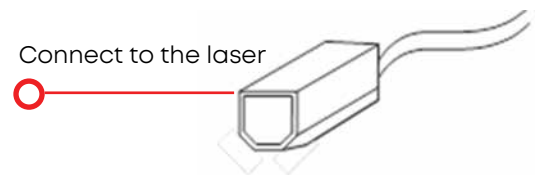

Ethernet Connection

The Ethernet Port is a standard 1000Base-T connection, and is backwards compatible with 100 and 10Base-T. Your Epilog Laser has all of the versatility of a network capable peripheral. As such, there are many different ways that the laser can be connected to a computer or a network. Connect the Ethernet cable (included in the accessories kit) to the Ethernet port, located on the right-hand side of the machine. Plug the cable into the Ethernet port on the laser, then plug the other end into the Ethernet port on your computer.

SECTION 2: GETTING STARTED

5. Power on the Laser

1. When you boot up the Fusion Galvo for the first time, you will need to set up a few settings in the unboxing wizard to get started. On the first screen, select your preferred language and then click the next arrow.



2. Next, enter a name for your machine. Then confirm that your laser's exhaust system has been set up by pressing the green next arrow.

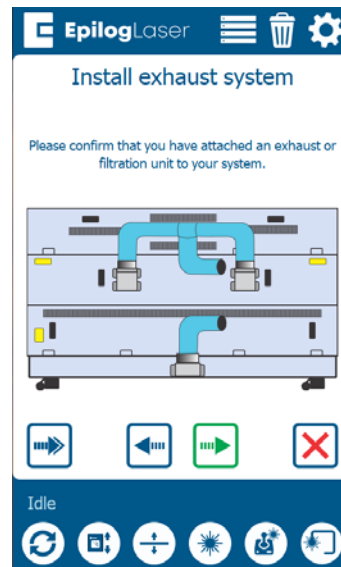

SECTION 2: GETTING STARTED

3. Follow the steps on the screen to run your first engraving using the anodized aluminum piece included in your Training Suite Kit. Press the green next arrow.

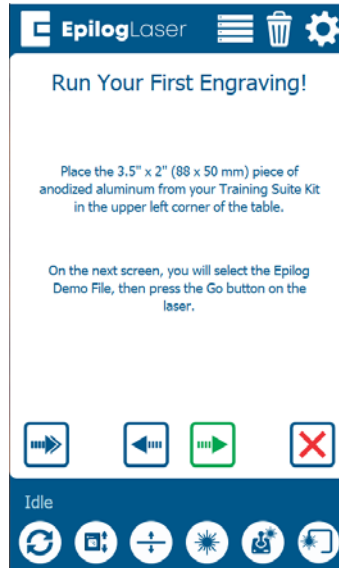

4. At the Job Menu, select the job "Epilog Demo" and then press the Go/Stop button at the machine to begin running your first job. The machine will automatically focus to the piece of anodized aluminum and then engrave it.



5. Once the engraving is complete, it's time to connect your Fusion Galvo to your computer. You can connect via Ethernet, USB, or Wireless connection in the steps on the following pages.
 - For Ethernet Setup, see **"Ethernet Setup" on page 22.**
 - For USB Setup, see **"USB Cable Setup" on page 23.**
 - For Wireless Setup, see **"Wireless Setup" on page 23.**

SECTION 2: GETTING STARTED

6. Set the Fusion Galvo's IP Address

Ethernet Setup

1. A screen will appear asking how you would like to connect your laser. Select **"Ethernet"**.



2. Select the text in the IP Address box and type in whichever IP Address you prefer to use. Most Epilog users will use the IP Address of **192.168.3.10** which is what we use in this manual. Press the **Green** arrow to complete the setup.

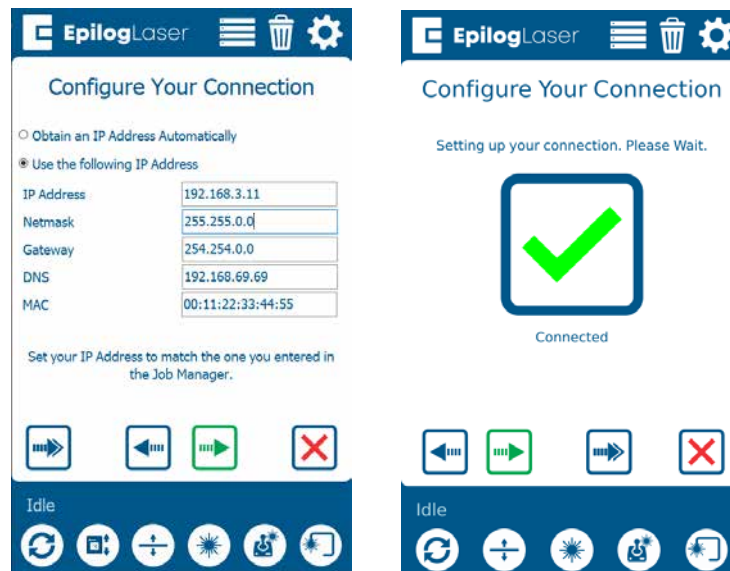

3. This will be the IP Address you use in the Job Manager when you set up your machine. For more information, see **"Using the Epilog Job Manager"** on page 39.

SECTION 2: GETTING STARTED

USB Cable Setup

1. A screen will appear asking how you would like to connect your laser. Select **“USB”**.



2. Enter the **“IP Address”** & MAC, the IP Address will be **169.254.7.2**. Press the **Green** arrow to complete the setup.

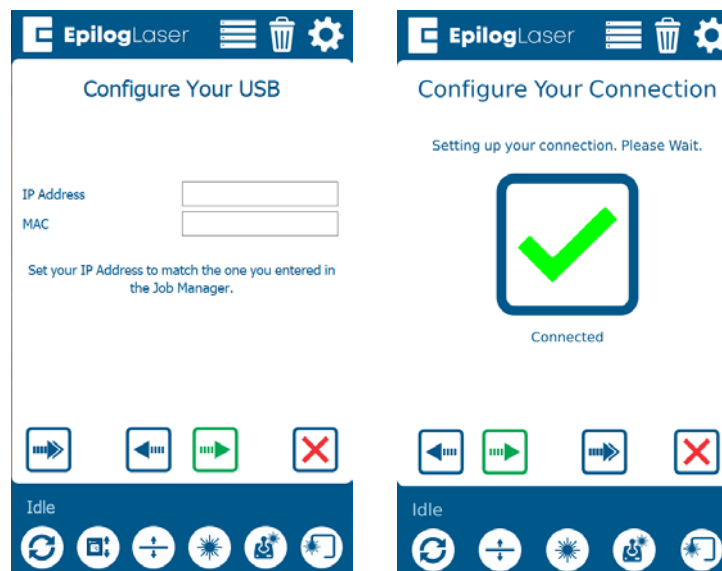

3. This will be the IP Address you use in the Job Manager when you set up your machine. For more information, see **“Using the Epilog Job Manager” on page 39**.

SECTION 2: GETTING STARTED

Wireless Setup

1. A screen will appear asking how you would like to connect your laser. Select **“Wireless”**.

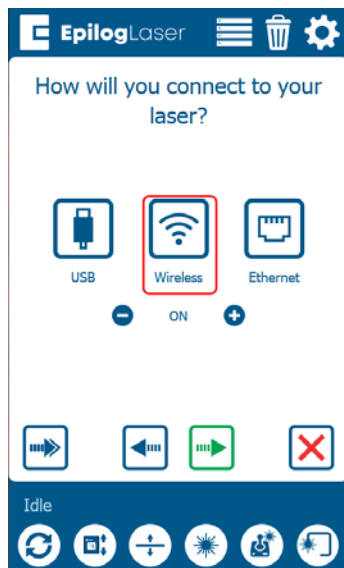

2. On the next screen, select your wireless network from the list and press the green next arrow. Select **“WPA2 Personal”** if you are connecting to a secured network. Select **Open** if you are connecting to an open network. Tap the box under **“Security Key”** and type in your password. Then press the green next arrow to connect.

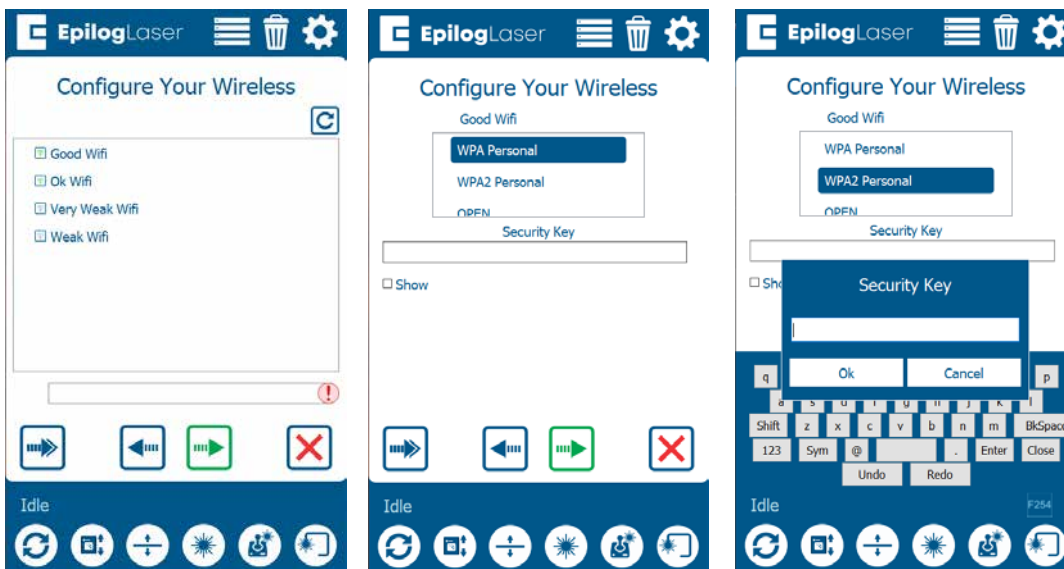

Note: You must select the same network that your computer is connected to.

SECTION 2: GETTING STARTED

3. Select “Obtain an IP Address Automatically” and click the green arrow to finish setup. Once connected, your screen will show a green check mark. Press the green next arrow.

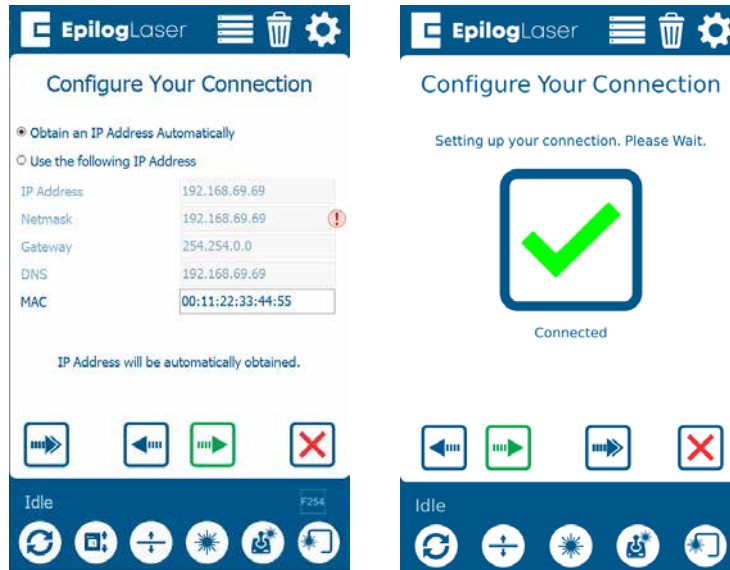

7. Install the Software Suite & Set Up Your Laser

Follow the instructions for the remainder of the setup. For detailed instructions on installing the Software Suite, see **“SECTION 3: SOFTWARE INSTALLATION” on page 27**. For detailed instructions on installing your laser in the Job Manager, see **“SECTION 4: THE JOB MANAGER” on page 39**.



SECTION 2: GETTING STARTED

8. Sign Up for Driver Updates and Register Your System

Go to www.epiloglaser.com/register and register your system. You can also sign up for our weekly e-newsletter, quarterly customer printed newsletter, and sign up for driver update notifications.

SECTION 3: SOFTWARE INSTALLATION

Epilog Software Suite Instructions

The Epilog Software Suite consists of the Job Manager & Dashboard. The Software Suite is a powerful new tool that will quickly become one of your favorite features on your laser system. From one piece of software, you can access any job you have sent to the laser, view the settings you used on any past job, re-run projects, access your material database, and much more.

- **Windows 7/8/10/11** is required to use the Epilog Software Suite.

Uninstalling the Previous Job Manager

If you have installed a previous version of the Job Manager on your computer, you must uninstall it first before you continue.

1. Go to Control Panel > Programs and Features and click on Epilog Job Manager

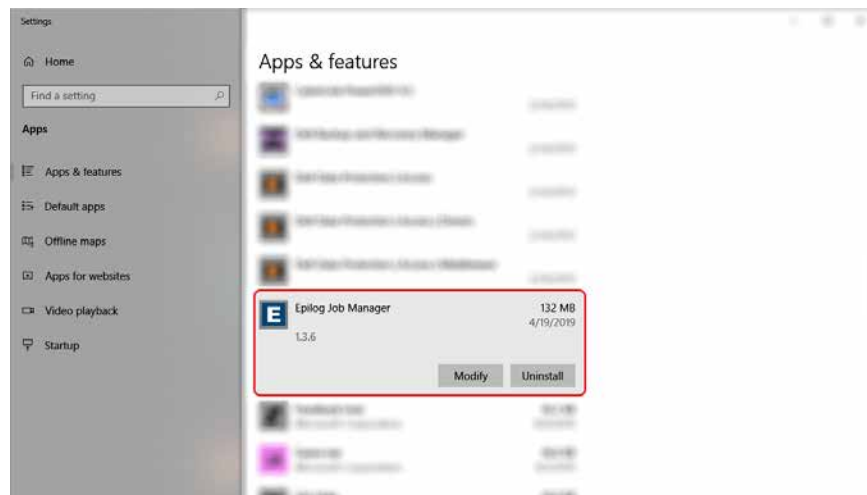

2. Click "Uninstall" and confirm if asked again.

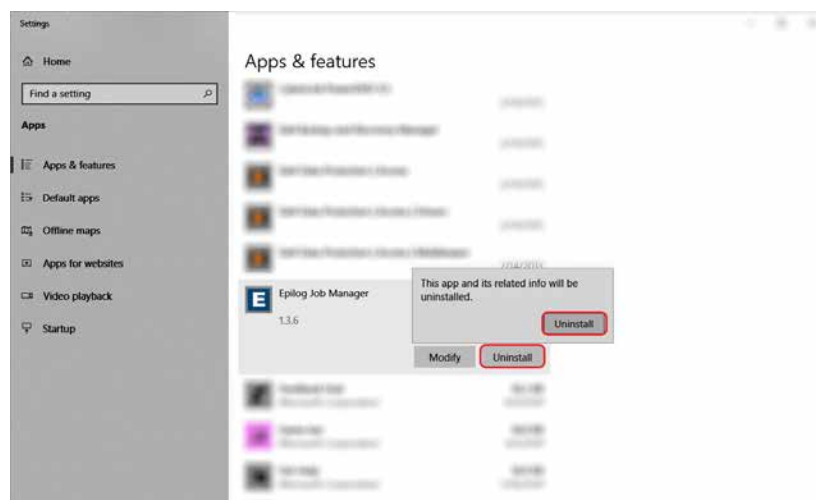

SECTION 3: SOFTWARE INSTALLATION

3. Select “Remove all components” and then click “Next”.

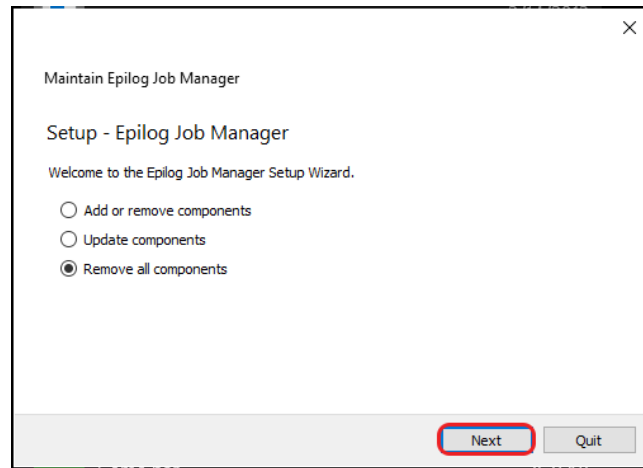

4. Click “Uninstall”.

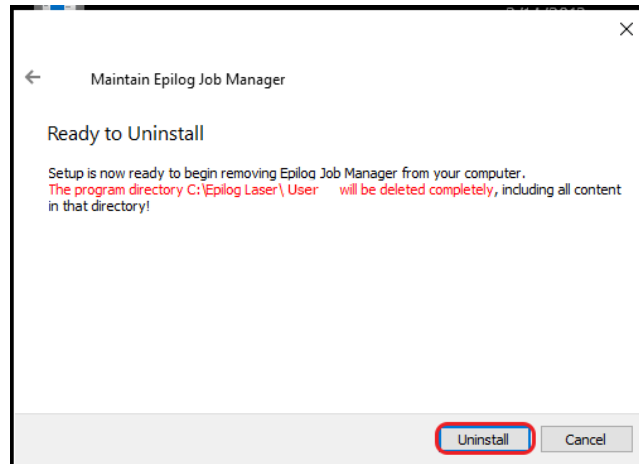

5. Click Finish to complete the uninstallation of the previous Job Manager.

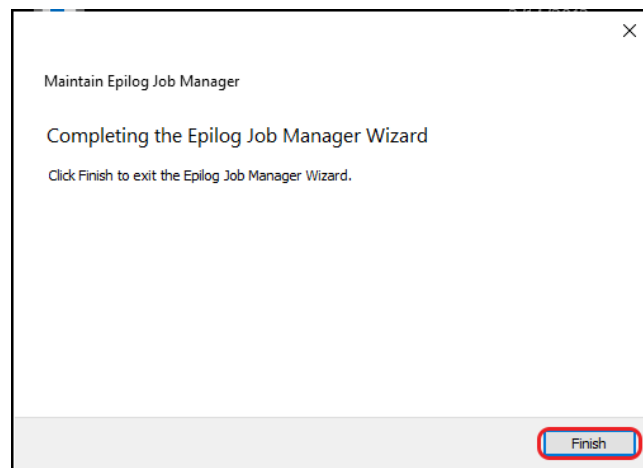

SECTION 3: SOFTWARE INSTALLATION

How to Install the Epilog Software Suite

1. Go to epiloglaser.com/drivers and select the Epilog Fusion Galvo. Then click on the Epilog Software Suite to download the installation file.
2. The installation file will download as a .zip folder that will need to be extracted. Right click the folder and click “Extract All”. Once finished, double click on the **EpilogSuite** file.



Note: Make sure that the “Ghostscript” folder included in the download is always in the same location as your Epilog Suite installation file, or the installation will not be able to complete.

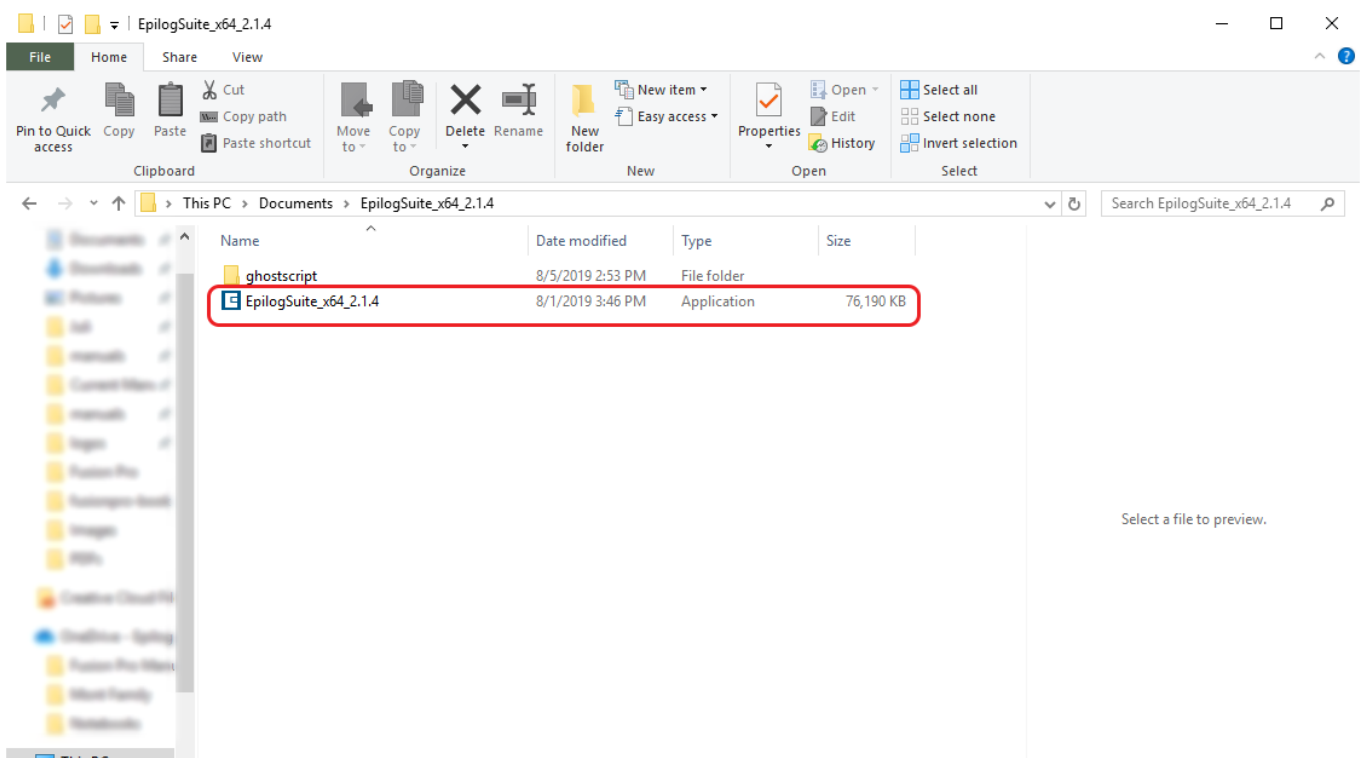

SECTION 3: SOFTWARE INSTALLATION

3. A welcome screen appears, click **Next**.

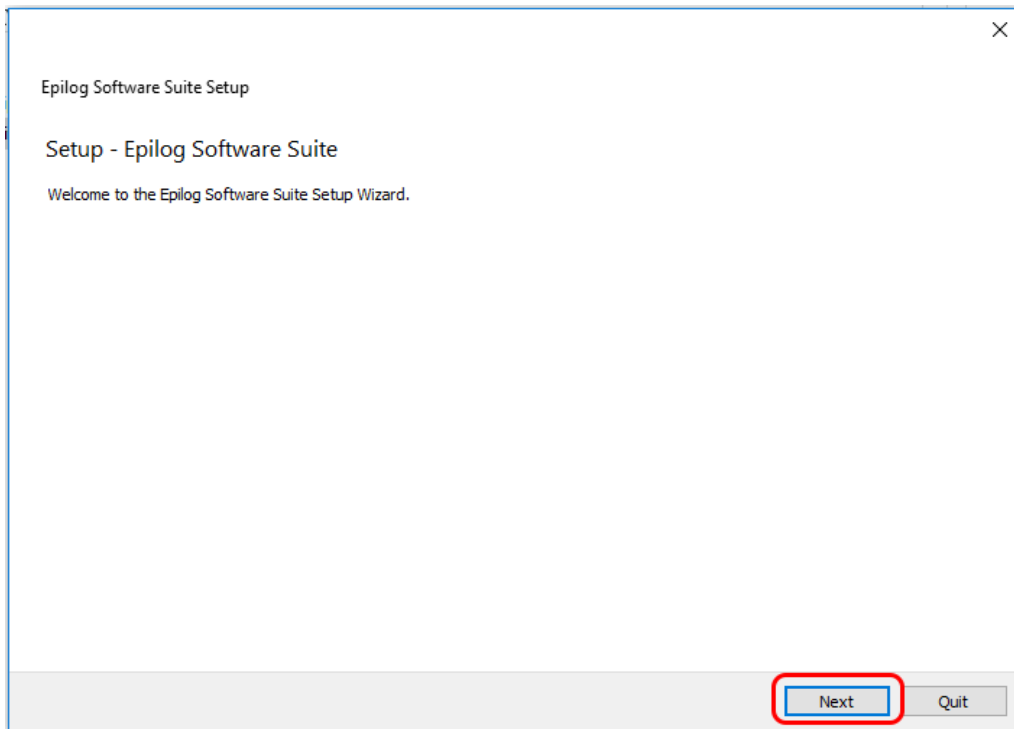

4. Select a directory location for the installation file and click **Next**.

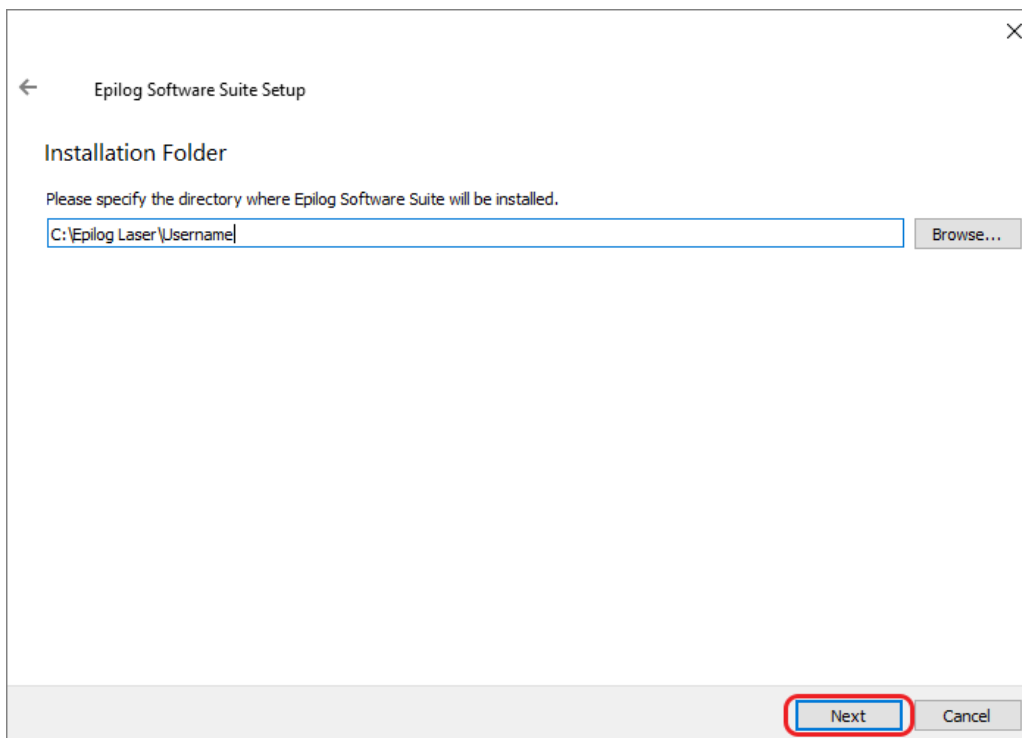

SECTION 3: SOFTWARE INSTALLATION

5. Read and accept the license agreements and click **Next**.

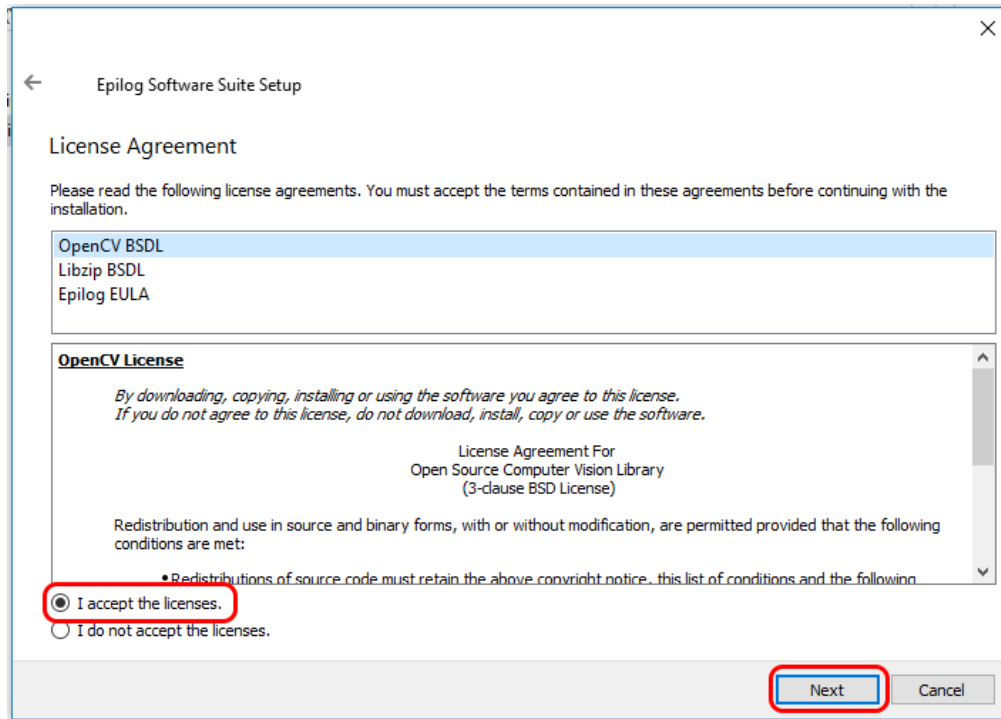

6. Click **Next** to use the default start menu, or choose a start menu name of your choice.

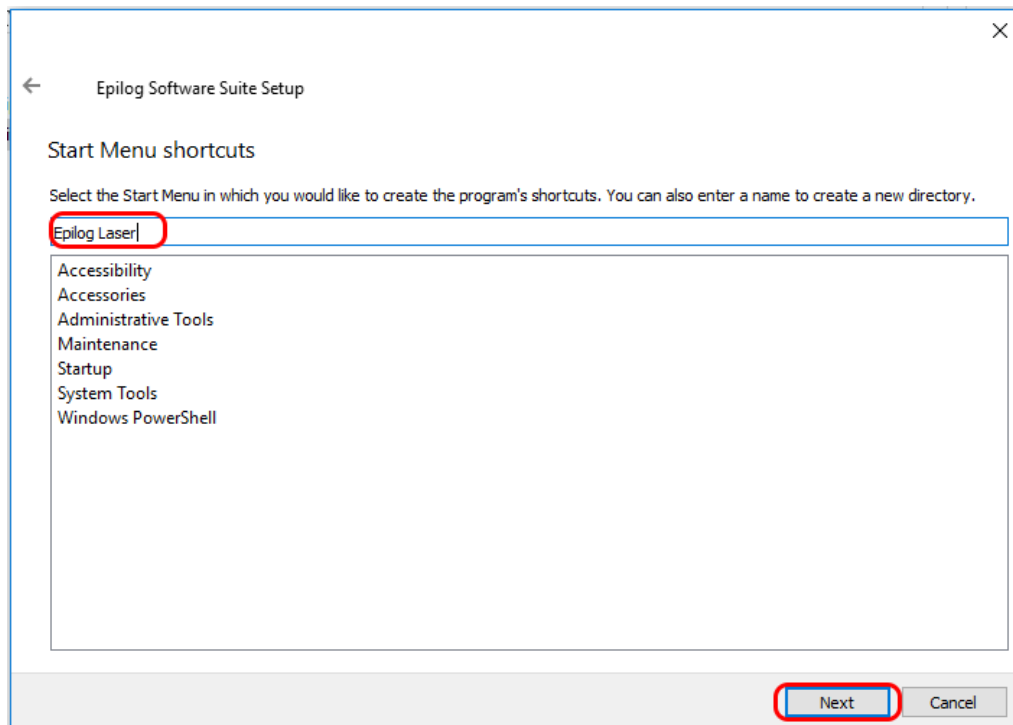

SECTION 3: SOFTWARE INSTALLATION

7. Click **Install** to begin the installation.

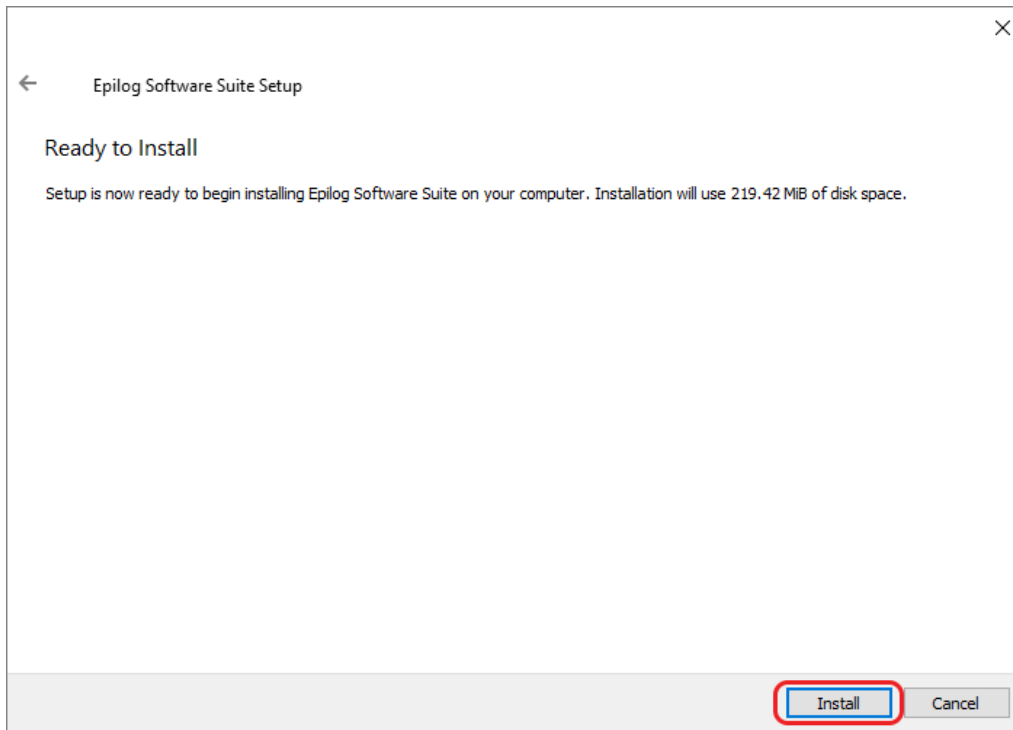

8. The Epilog Software Suite will begin installing, during the installation a dialog box will pop up to also install the AGPL Ghostscript Package, click **Next**.

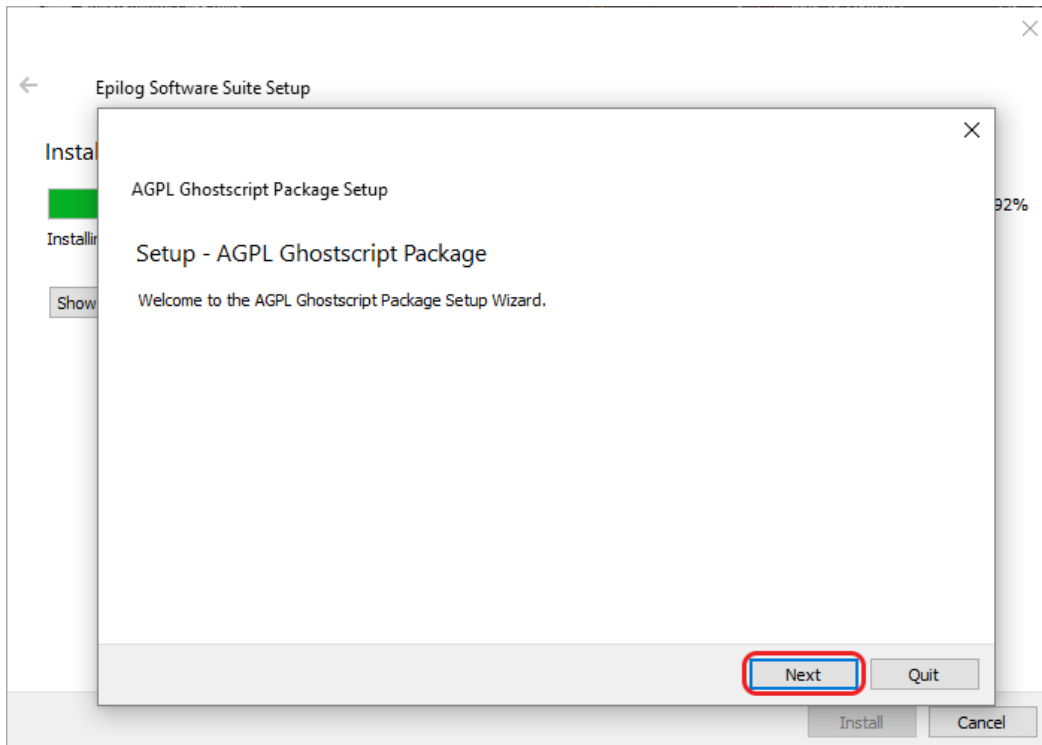

SECTION 3: SOFTWARE INSTALLATION

9. Read and accept the AGPL Ghostscript License Agreement, then click **Next**.

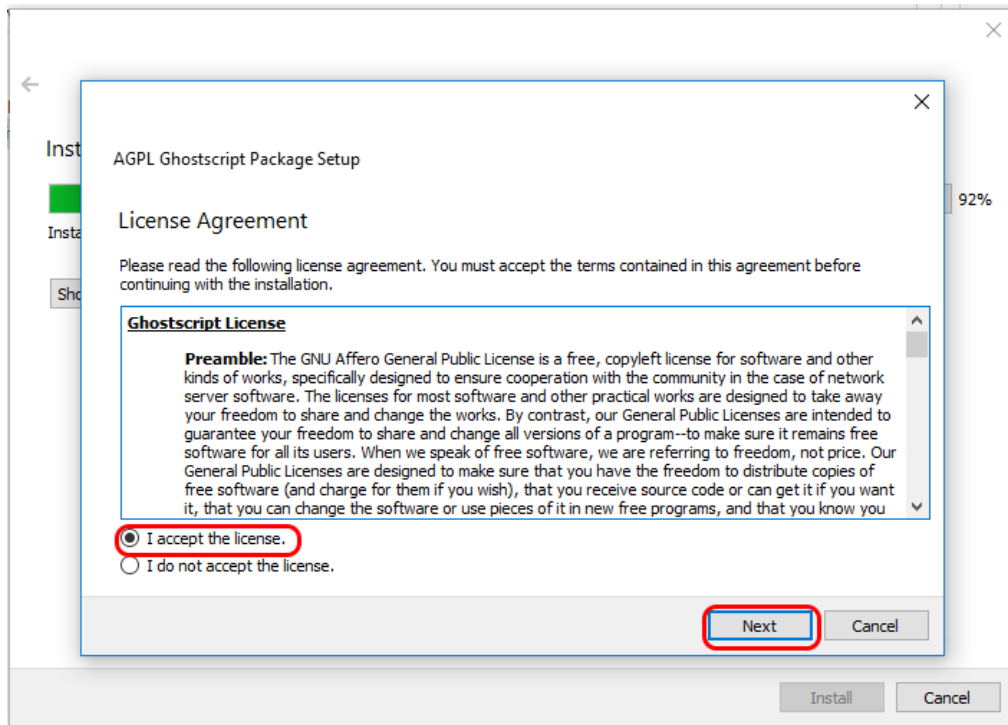

10. Click **Finish** to complete the AGPL Ghostscript installation and resume the Epilog Software Suite installation.

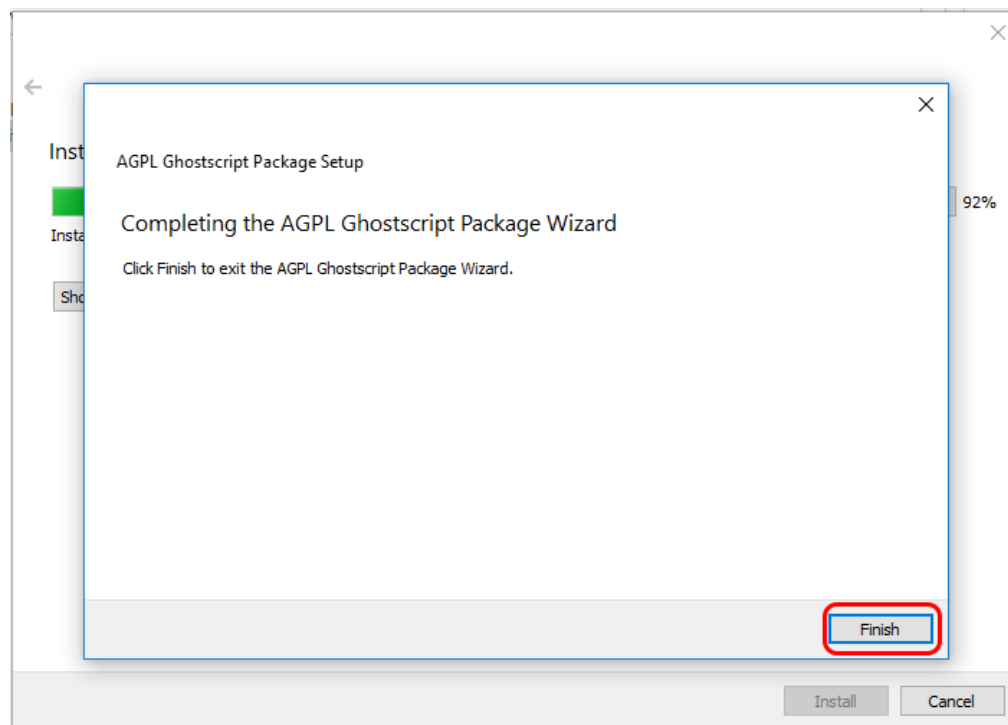

SECTION 3: SOFTWARE INSTALLATION

11. Select whether or not you want to run the program now. Click **Finish** to complete the installation.

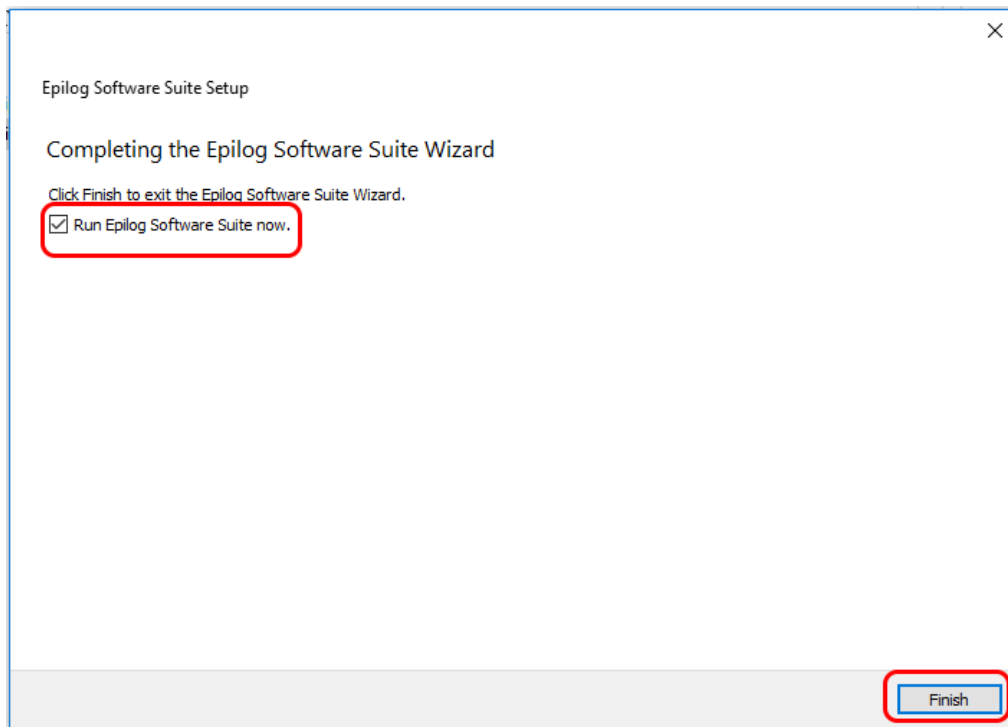

12. An icon for the Job Manager will be automatically added to your Desktop. You are now ready to use the Job Manager.

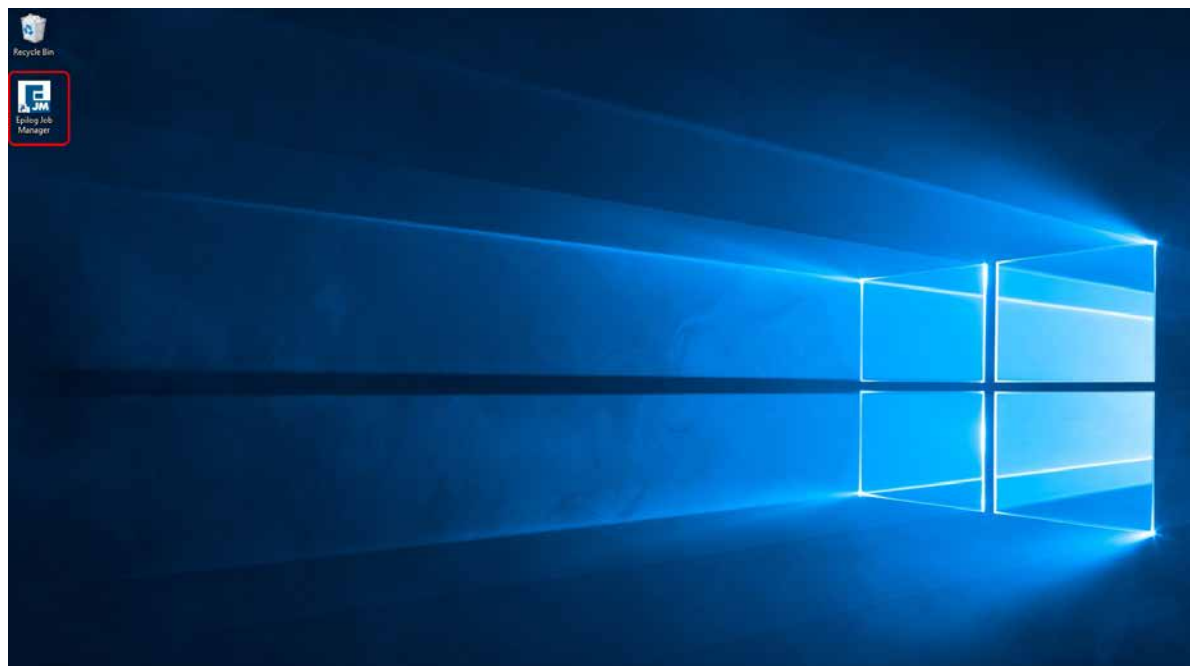

SECTION 3: SOFTWARE INSTALLATION

Windows 8/10: Ethernet Installation

Set Up TCP/IP Address in the Computer

Go to your Network and Sharing Center in your computer's Control Panel.

1. Click **Change Adapter Settings**.

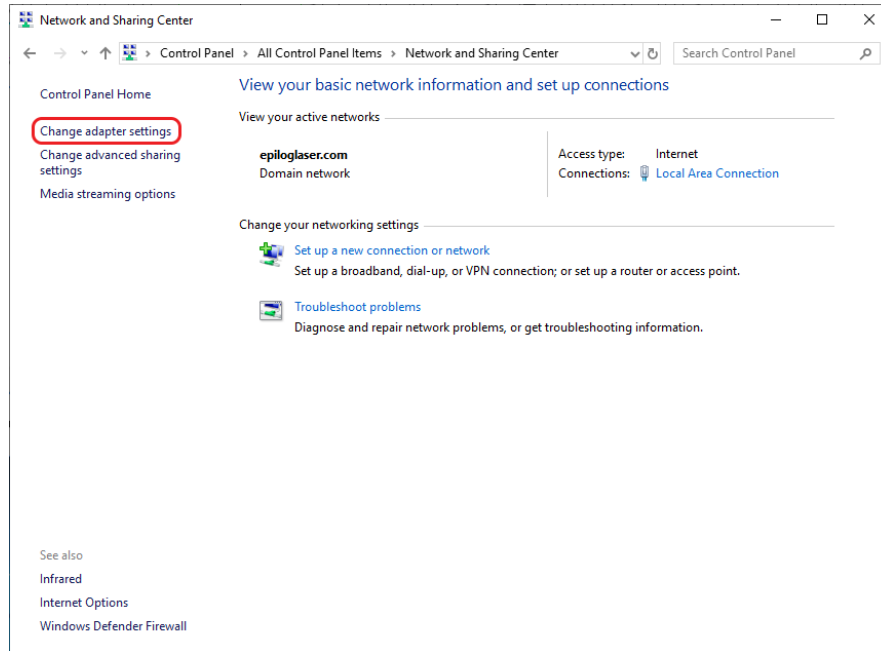

2. Right click **Local Area Connection**, then click **Properties**.

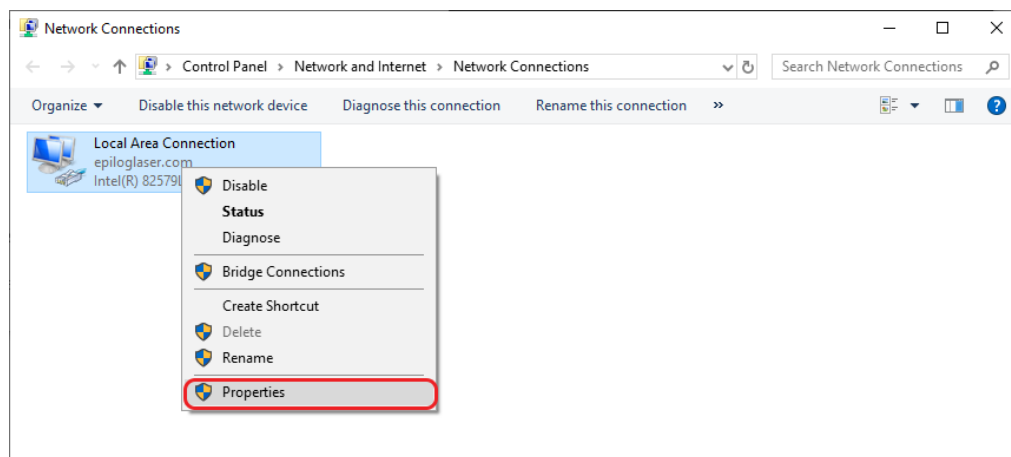

SECTION 3: SOFTWARE INSTALLATION

3. Select **Internet Protocol Version 4 (TCP/IP)**. Make sure you do not select Version 6. Then click **Properties**.

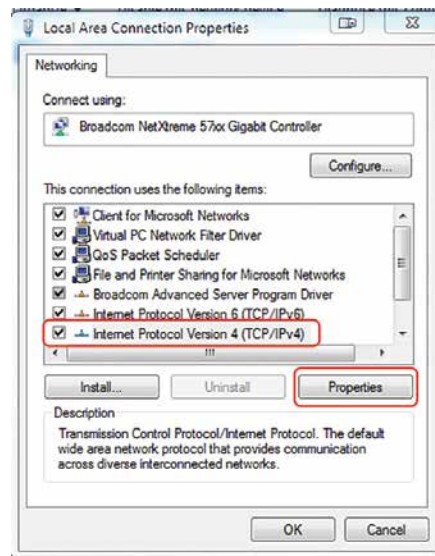

4. Select **Use the following IP Address**. Type in the following IP Address: **192.168.3.3**.



This number is not an error; the last digit of the IP address in **this window must be different than the IP address you set in the laser**.

5. Type in a Subnet Mask of **255.255.255.0**, then click **OK**.

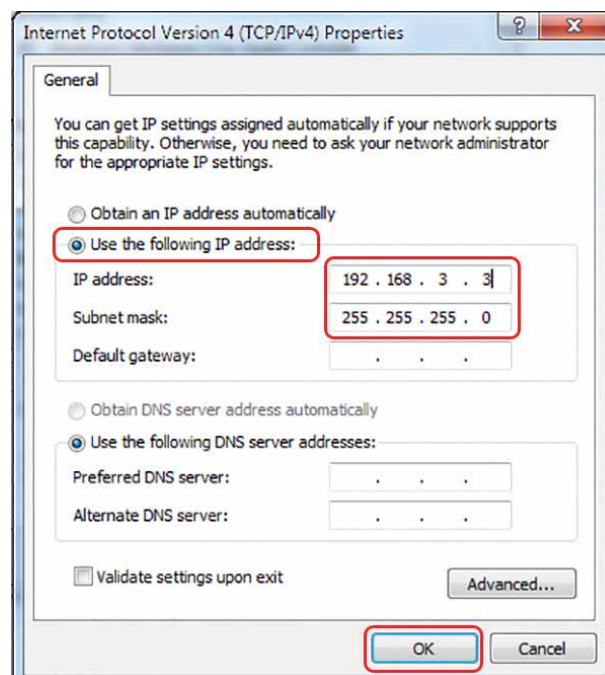

SECTION 3: SOFTWARE INSTALLATION

Windows 8/10: USB Installation

To prepare your computer for USB installation, the IP Address under your Internet Protocol properties should be set to “Obtain an IP address automatically.”

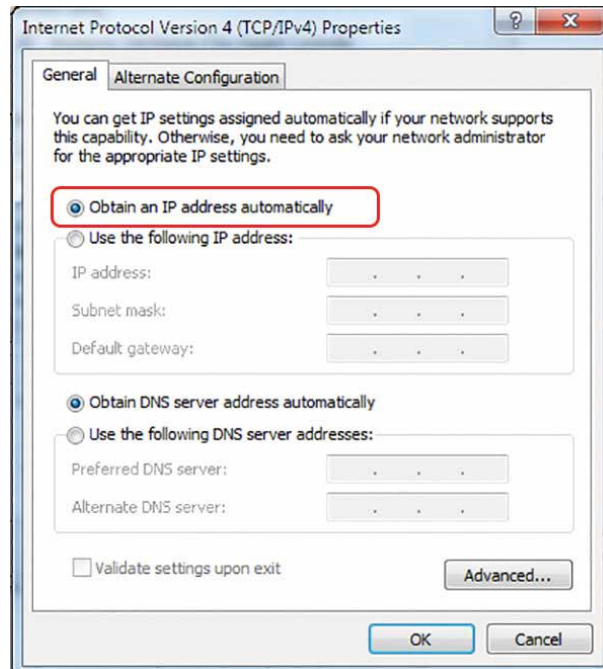

The IP Address on your machine should also match the IP Address on the Job Manager. **For more information, see “USB Connection” on page 19.**

Troubleshooting the Job Manager

If you were unable to install the Job Manager, it’s possible that your Anti-Virus software is blocking installation. To disable Symantec Anti-Virus software, choose **Options**. Other anti-virus packages should have something similar to Symantec.



SECTION 3: SOFTWARE INSTALLATION

Disable all Virus and Spyware Protection Features. After the Job Manager has been installed go back into your Anti-Virus software and re-enable the setting that was disabled.

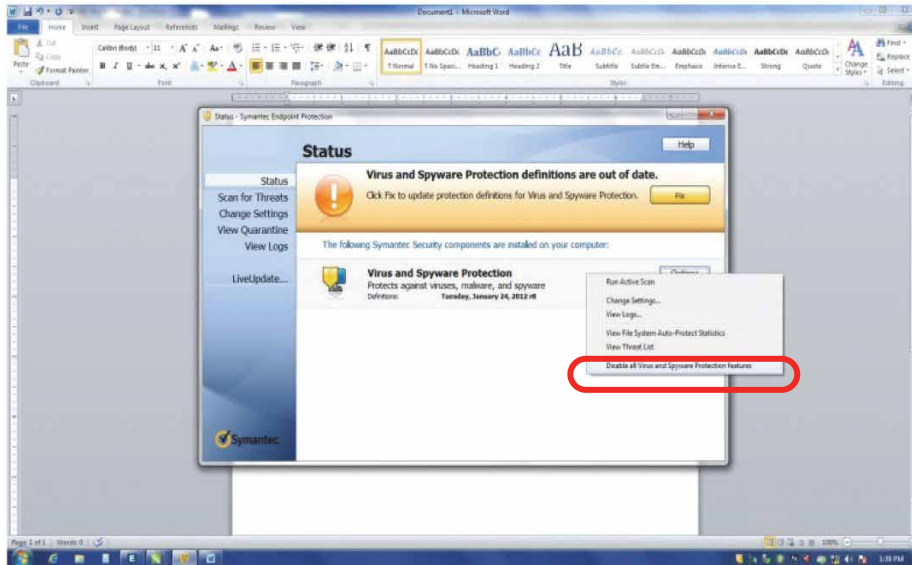

Important Job Manager Notes

-  **Warning:** Before activating your laser, install the newest version of the Software Suite to properly associate the correct machine with the Job Manager.
- We suggest a minimum of **1 GB of free RAM** space when managing very large engraving and vector jobs.

SECTION 4: THE JOB MANAGER

Using the Epilog Job Manager

1. The first time you open the Job Manager you will need to add your machine, select “Add Laser System” to begin.



Note: You will need to activate two separate laser systems in the Job Manager for both 4”x4” & 6”x6” field sizes of the Fusion Galvo G100.

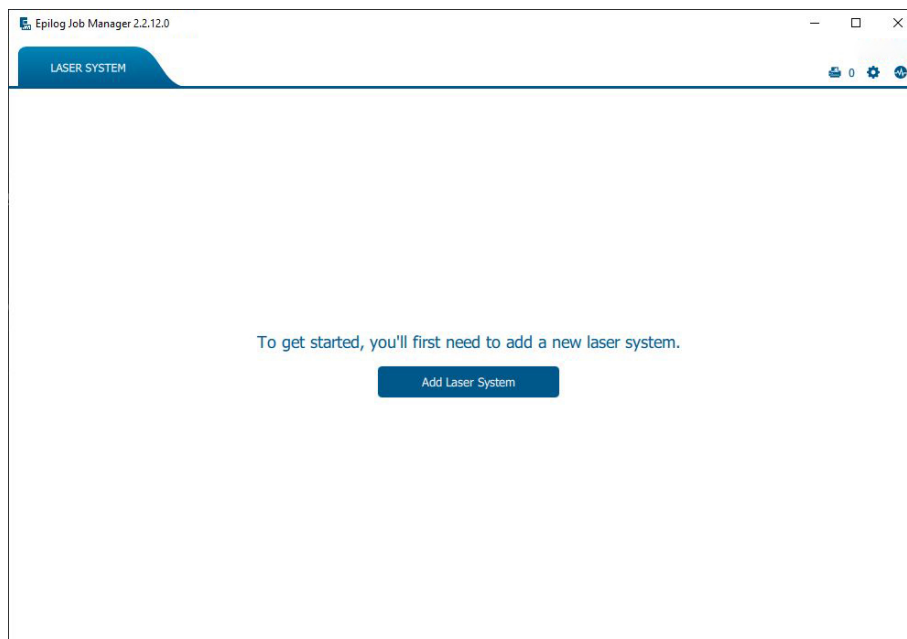

2. Next you will see a tab for each of the machine models. Select the correct model.

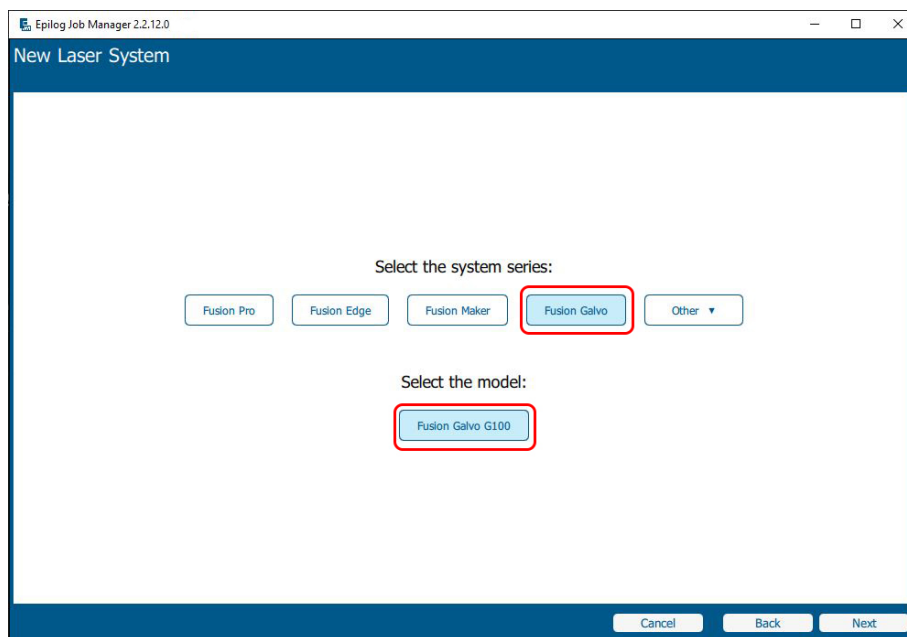

SECTION 4: THE JOB MANAGER

3. Select which Fiber laser is installed in your machine.

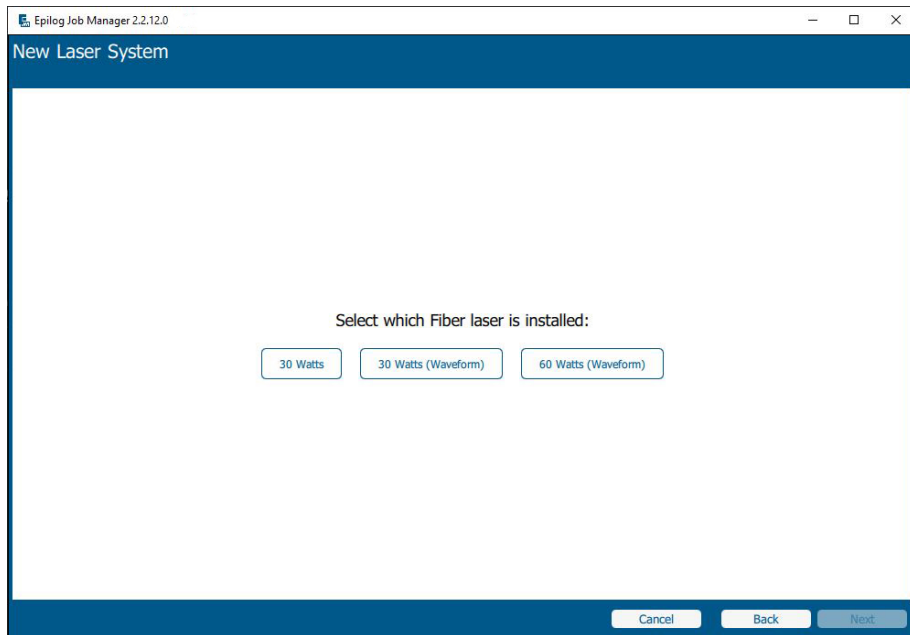

Epilog Job Manager 2.2.12.0

New Laser System

Select which Fiber laser is installed:

30 Watts 30 Watts (Waveform) 60 Watts (Waveform)

Cancel Back Next

4. Enter the IP Address, Serial Number and Field size, then click **Next**.

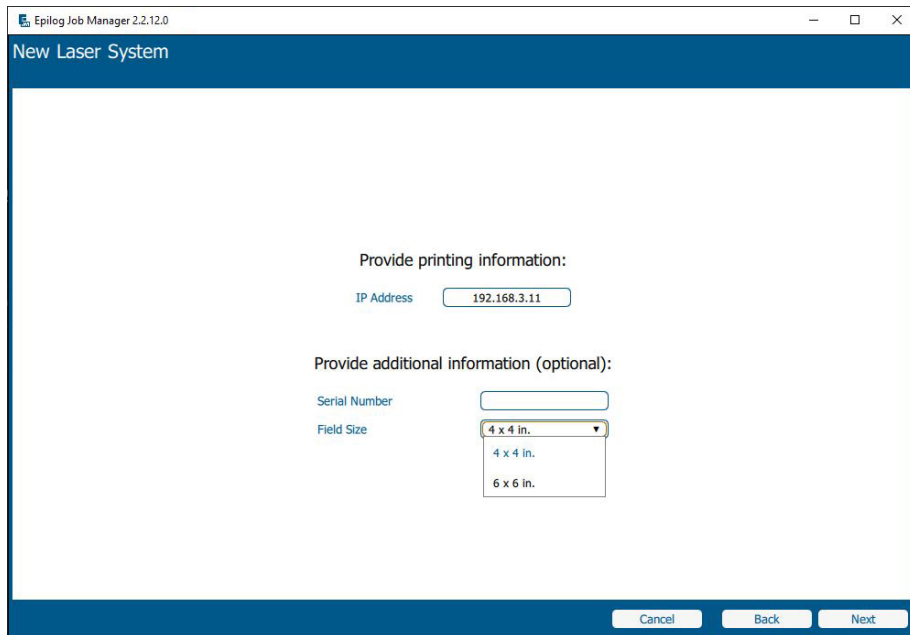

Epilog Job Manager 2.2.12.0

New Laser System

Provide printing information:

IP Address 192.168.3.11

Provide additional information (optional):

Serial Number [Empty Field]

Field Size 4 x 4 in. (selected)
4 x 4 in.
6 x 6 in.

Cancel Back Next

5. Lastly, give this laser system a name.



Note: We recommend using the wattage and field size in the name.

SECTION 4: THE JOB MANAGER

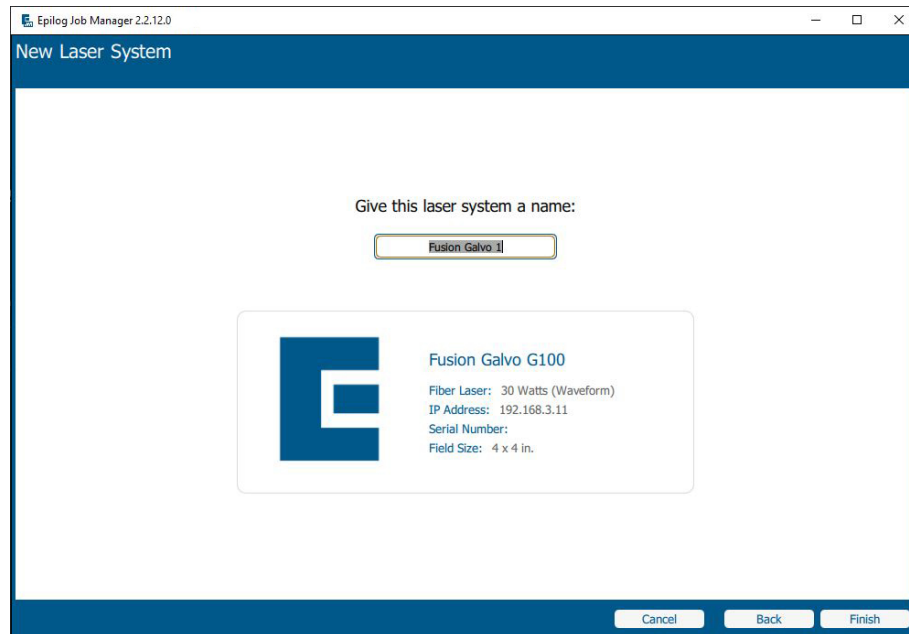

6. Your new laser has been activated in the Job Manager and now appears in the left panel. It is now ready to accept jobs from the print driver. Use the **Add or Delete** buttons to add or remove additional machines.



Remember, you will need to activate two separate laser systems in the Job Manager for both field sizes of the Fusion Galvo G100

SECTION 4: THE JOB MANAGER

Printing to the Epilog Job Manager

Create a file in your graphic software and select **Print**. When the print dialog opens up, make sure you select **Epilog Engraver** as your printer and set the Page to **Match Orientation and Size**. Once your desired settings are selected, click **Print** again.

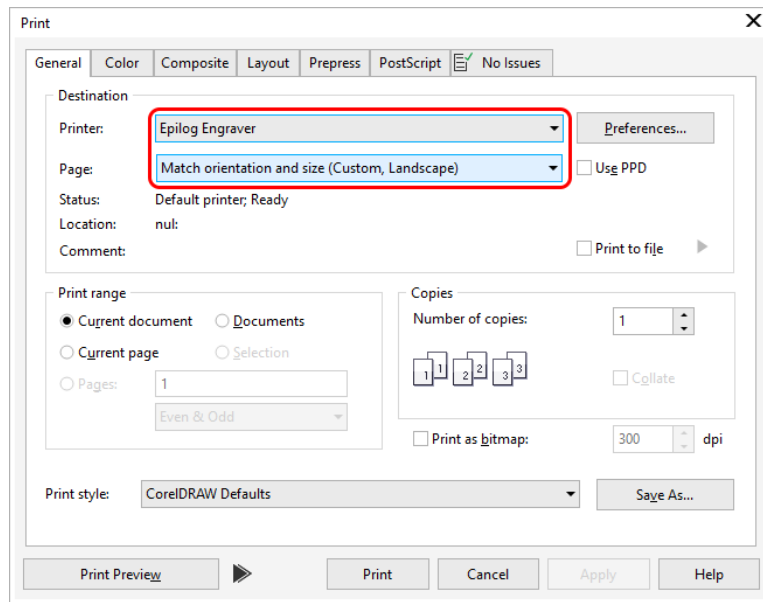

The file will open in the **Epilog Dashboard** first. To send it to the Job Manager, click the **“Send to JM”** button. The Job Manager window will open and the Dashboard window will close.

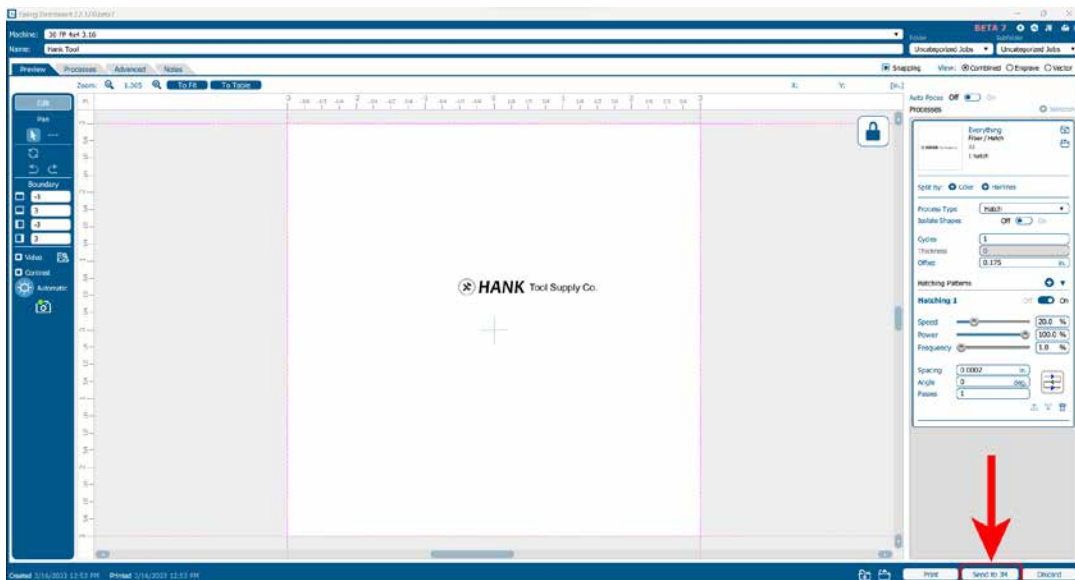

SECTION 4: THE JOB MANAGER

Organizing Your Print Jobs

Once the Job Manager is open, click the **Jobs** tab. All print jobs sent to the Job Manager from the Dashboard will be displayed in the **Uncategorized Jobs** folder by default. Printed jobs that are not sent to the Job Manager can be found in the **Temporary Jobs** folder. Click on your job to highlight it. You can now Print, Edit, Preview, Move or Delete this job using the available icons.



Create and Delete Job Folders

Click the **“Add Folder”** icon to add new folders. You can add as many folders as you’d like.



SECTION 4: THE JOB MANAGER

Type in the folder name and click the **check mark** to create your new folder.

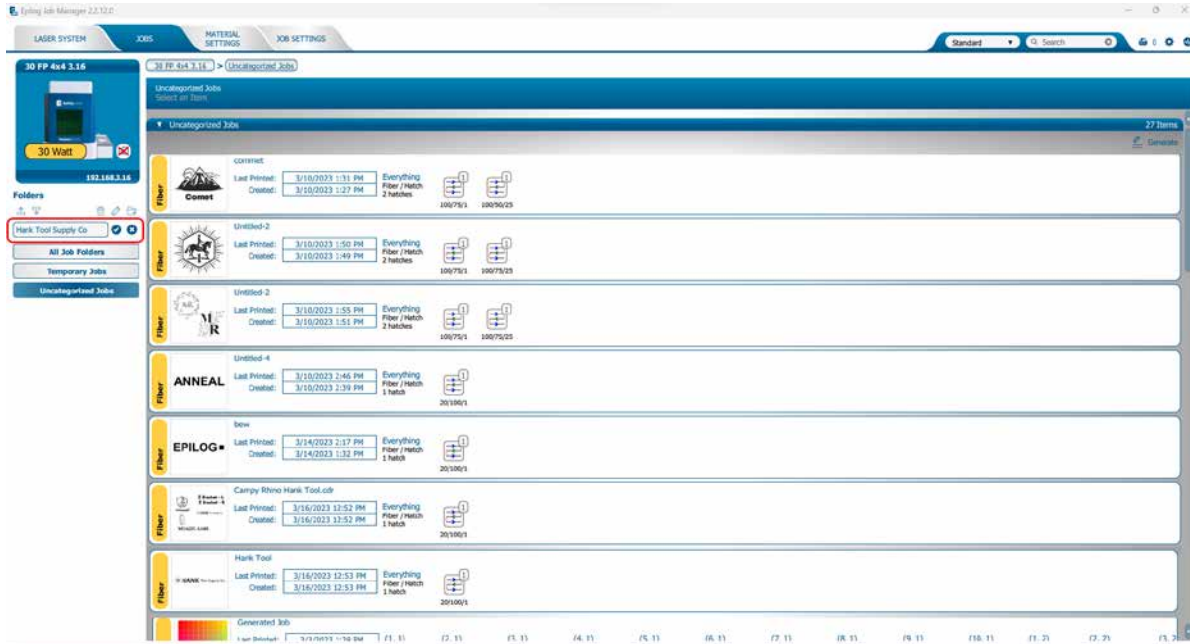

Move an Uncategorized File to a Folder

When you select a folder, you will see **From Uncategorized** on the right side of the folder. Click **From Uncategorized** to move a job from the Uncategorized Jobs folder to this subfolder. **Select the job** you want to move and click **OK**.

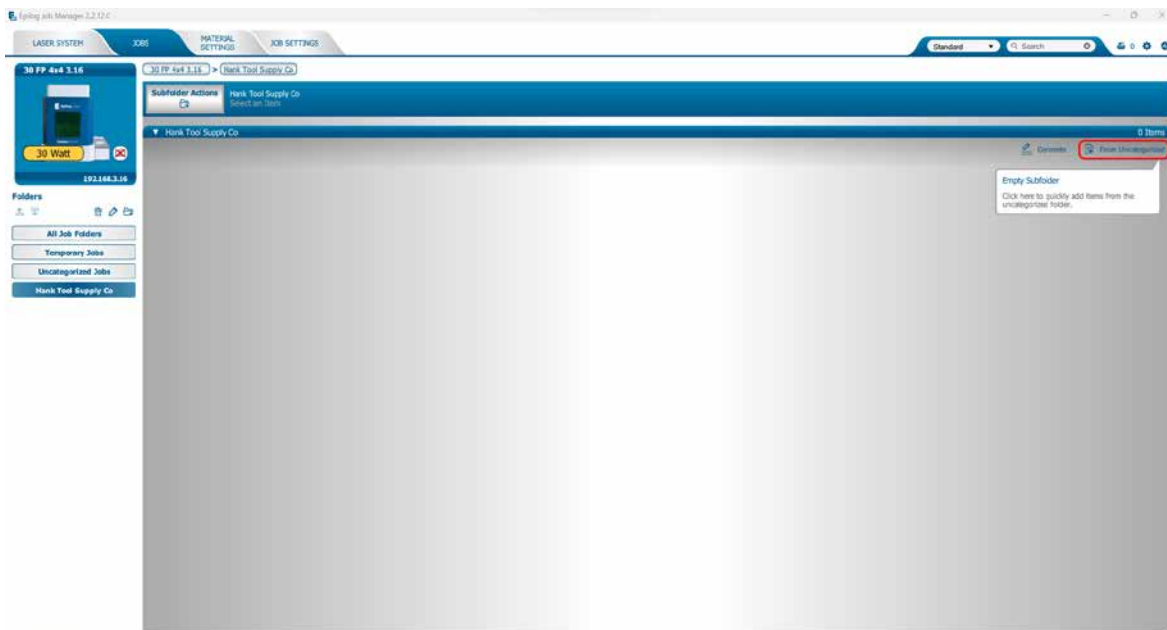

SECTION 4: THE JOB MANAGER

Create Subfolders

First, select the folder in the left panel where you want to add a subfolder. Below we have selected the Betty's Electronics folder. Click the **Add Subfolder** icon. Type the subfolder name in the **Add Subfolder** field, then click the **check mark** to create the subfolder.

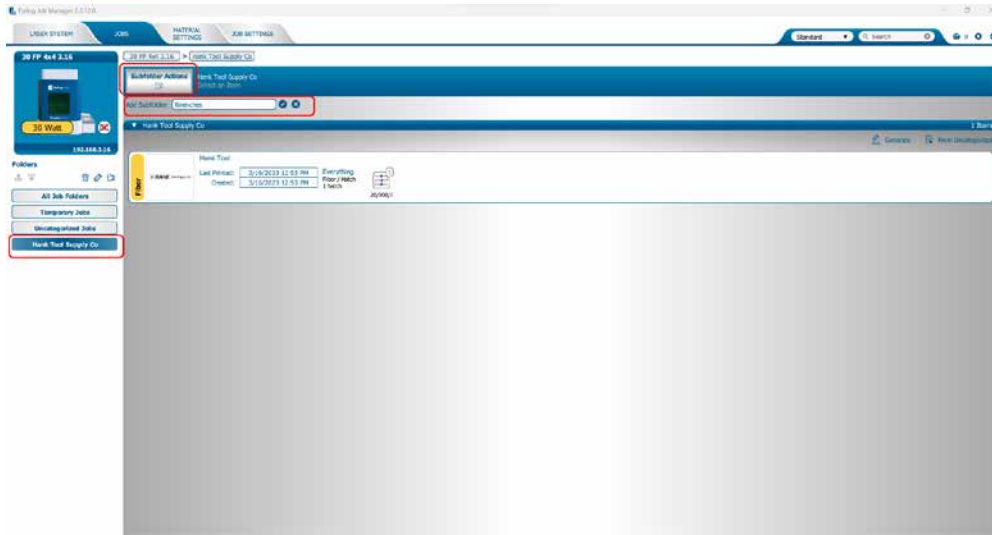

Move a Job Between Folders

You can also move any job to another folder or subfolder by **clicking and dragging** it up or down between folders. An arrow will indicate where you are placing the job. Once you see the arrow selecting the correct folder, let go of the job file to place it in that folder.

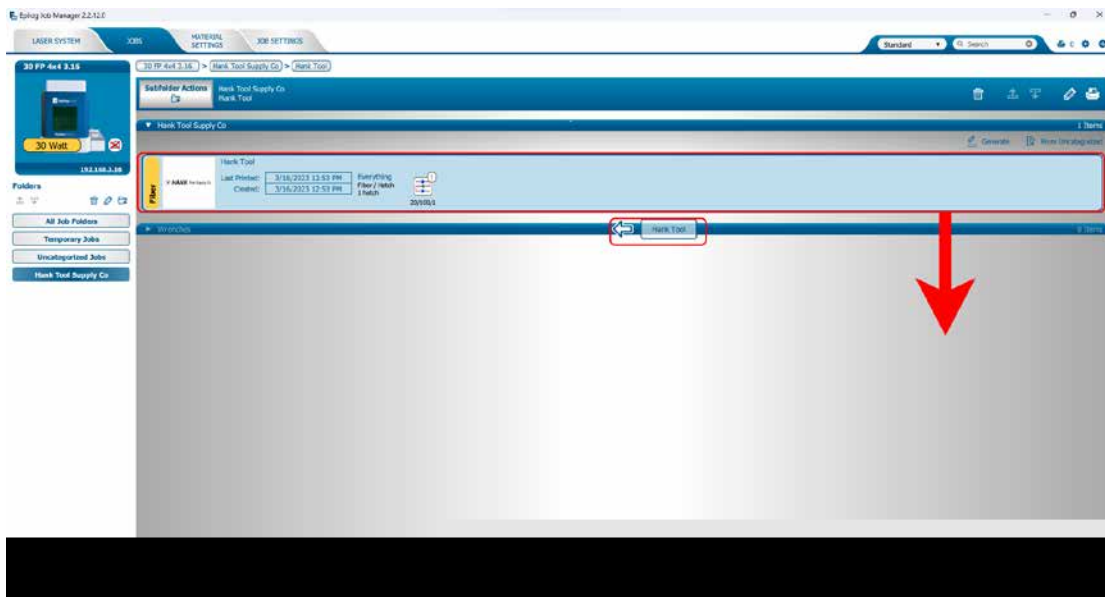

SECTION 4: THE JOB MANAGER

Switch Machine Selection

By clicking on the machine photo in the upper left corner, you can quickly change which machine model you want to have active.

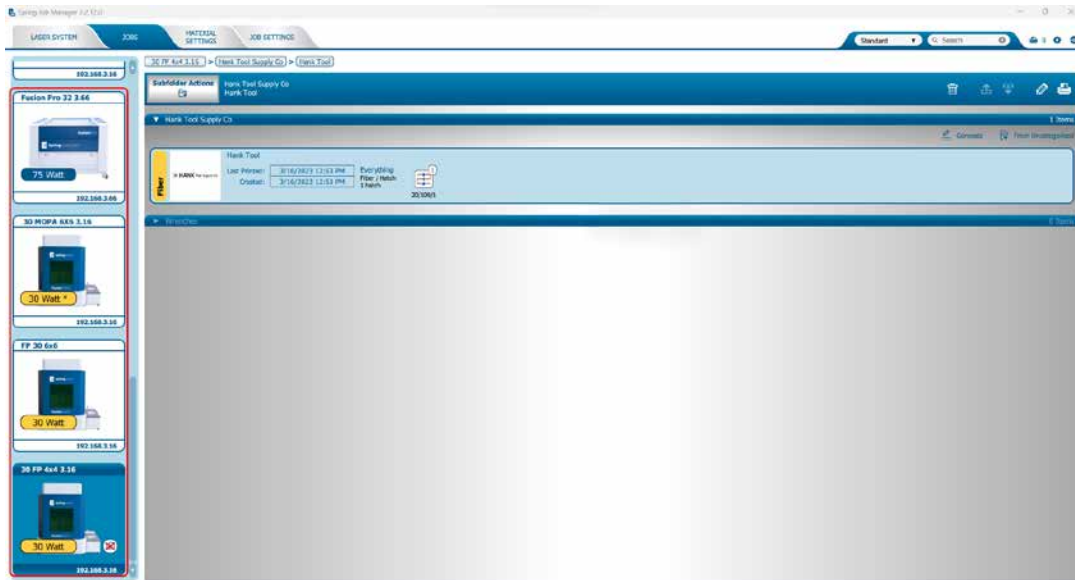

Previewing Your Job

To view a live preview of the job, double click on a job in the Jobs Tab. A Preview Tab will open and you can preview the combined raster vector job, just the raster components, or just the vector components.



SECTION 4: THE JOB MANAGER

Searching for a Job

The Job Manager has a powerful search function. Type in part of a file name and press enter to find all files related to that name. You can organize files by **Standard**, **Created**, **Last Printed**, or **Alphabetically** to find a specific file.

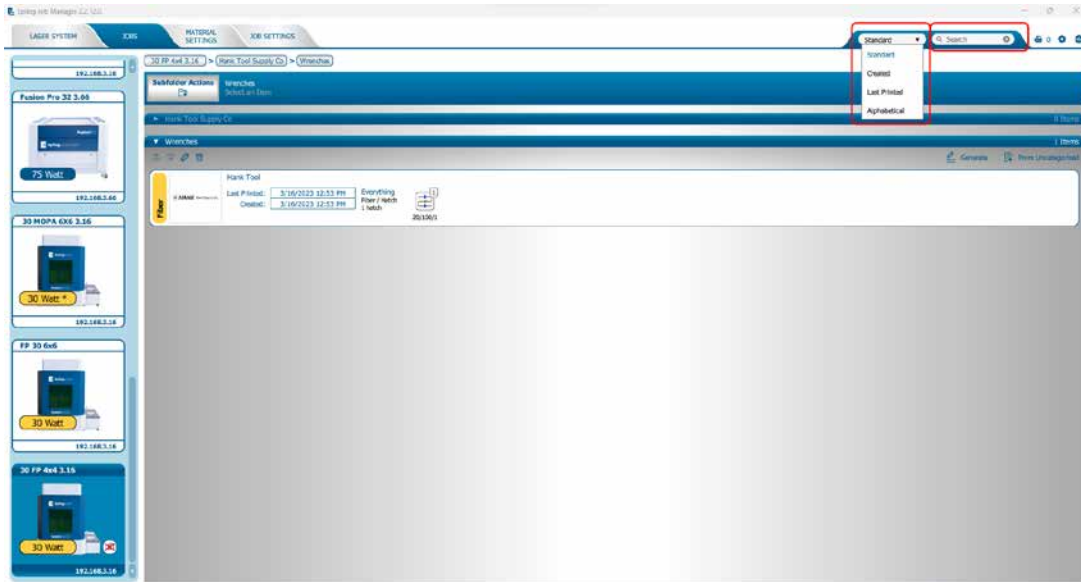

Notice that the jobs are displayed differently if you change the search category to **Alphabetical**. Your jobs are now displayed in alphabetical order. Once the search is finished, most users revert back to the default selection of **Standard**.

Finding Job History

You can find the **Job Manager Print History** under the **Laser System tab** to see a full print history of a machine, including settings you used in each print. Clicking on each job will expand it and reveal its settings. Clicking on each machine's icon on the left will only reveal the print history on the selected machine.

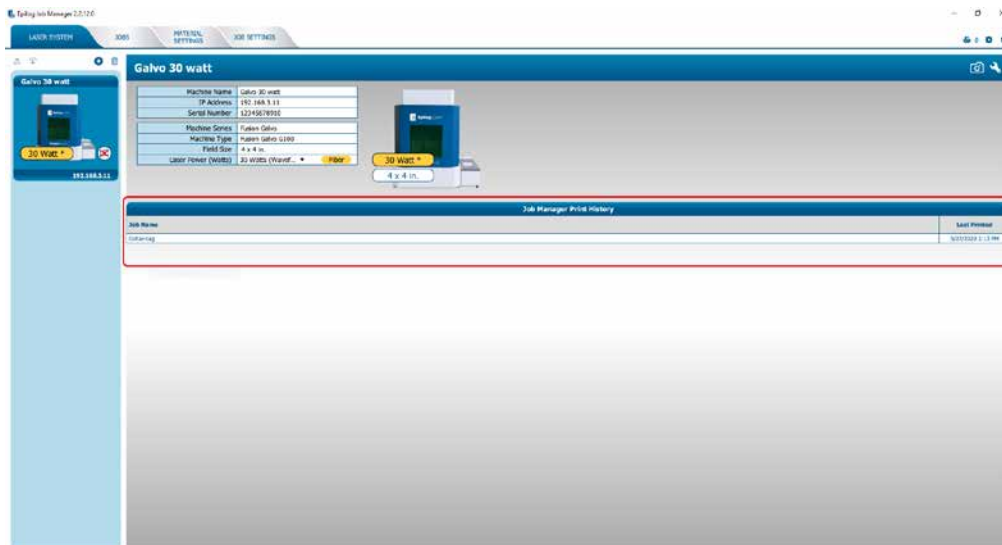

SECTION 4: THE JOB MANAGER

Under the **Jobs** tab you can modify, print or save jobs from this window using the listed settings or with new settings. The new settings will be saved as the next print job complete with time stamp and date. You'll see which machine it was printed to, when it was first printed (Initial Print), all subsequent prints, and all laser parameters used. To access this, double-click on the job, then select **History**. To view the laser parameters of this job, click on the print version. In this example we have clicked on the Initial Print.

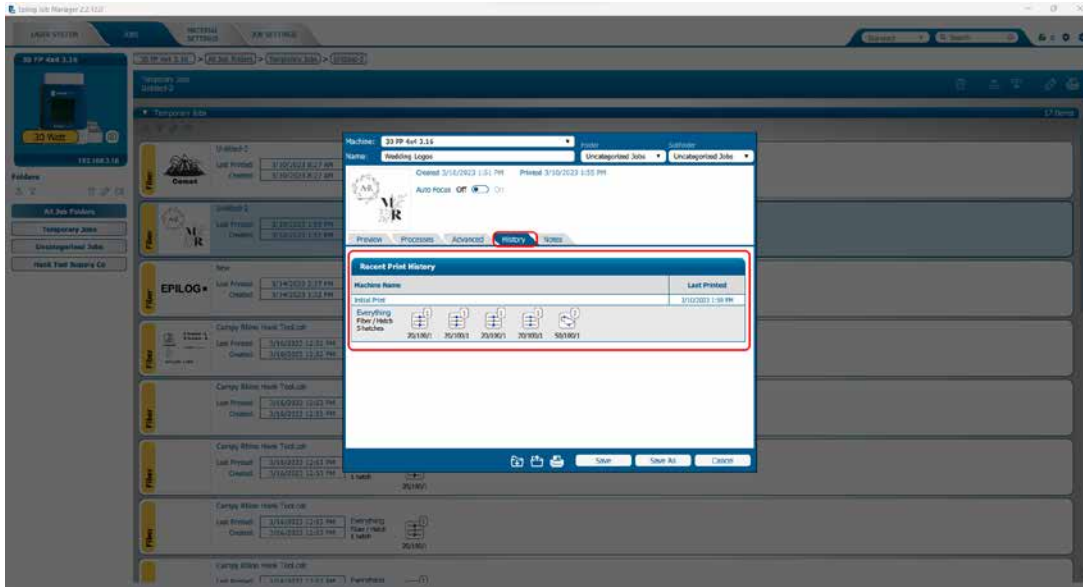

Vector Sorting

You can determine the cutting order of vector lines directly from the Epilog Job Manager. You can choose from three different vector sorting options:

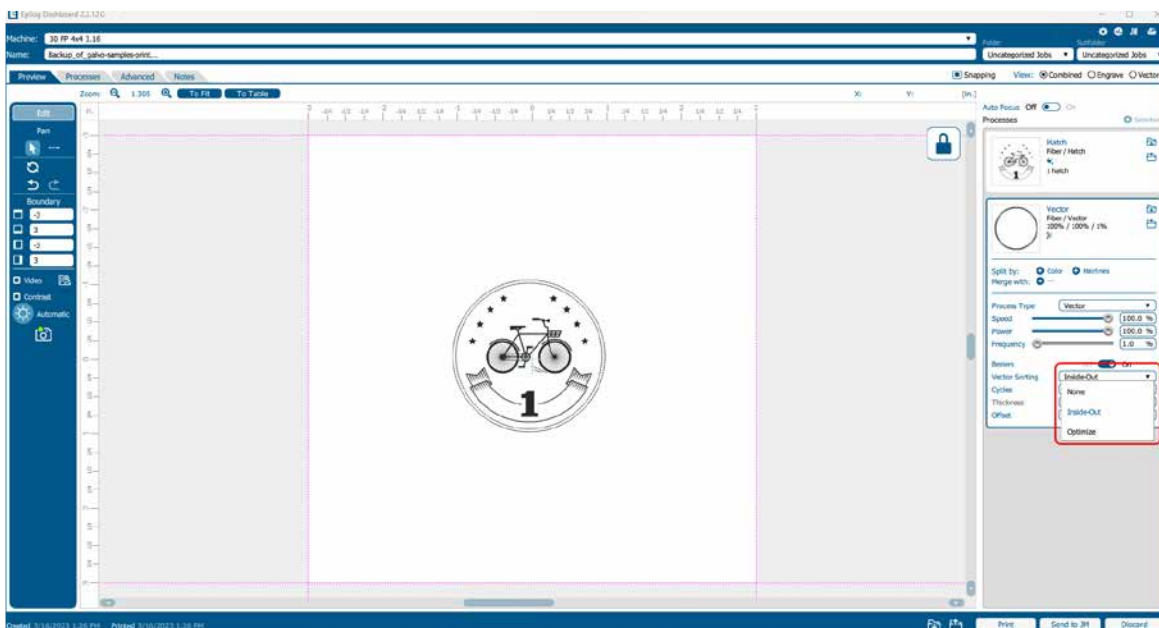

SECTION 4: THE JOB MANAGER

1. **None:** Vector line cutting order is determined by the order they were created.
2. **Inside/Out:** All internal vector paths in the file will be processed prior to the external vector paths. For example, if cutting the letter O, the inner oval will be cut before the outer oval.
3. **Optimized:** The laser will process the vector lines looking for the next closest node for quicker vectoring.

Material Settings Tab

The **Material Settings** Tab allows you to save and import settings for individual processes. If you frequently use the same settings for engraving or cutting, this feature allows you to import those settings into a single process quickly. You may follow these steps to create folders in the **Job Settings** tab as well.

Saving Material Settings

1. To save a process setting, first you need to create a folder in the Job Manager under the Material Settings Tab by clicking the “Add Subfolder” button.

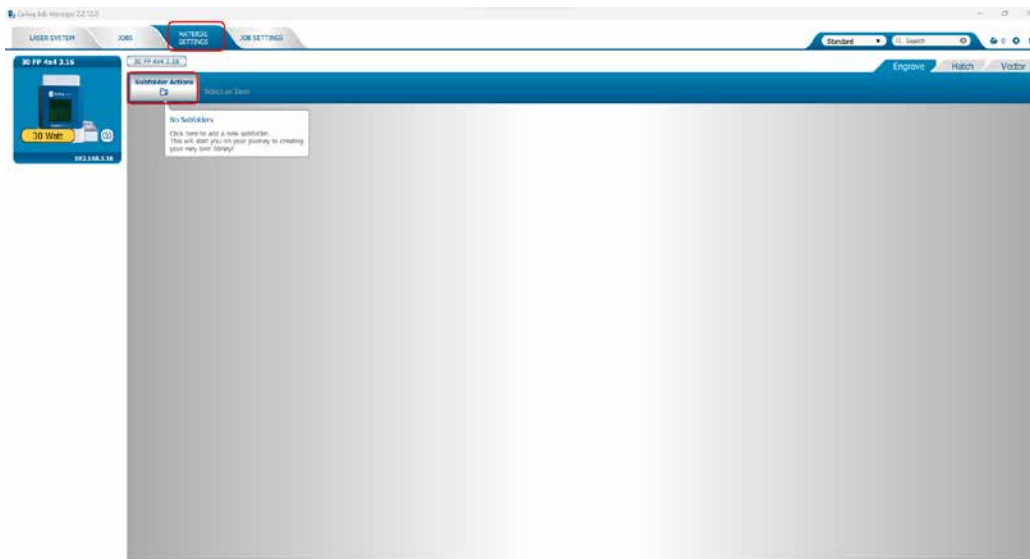

SECTION 4: THE JOB MANAGER

2. Name the folder and click the check mark to save it.

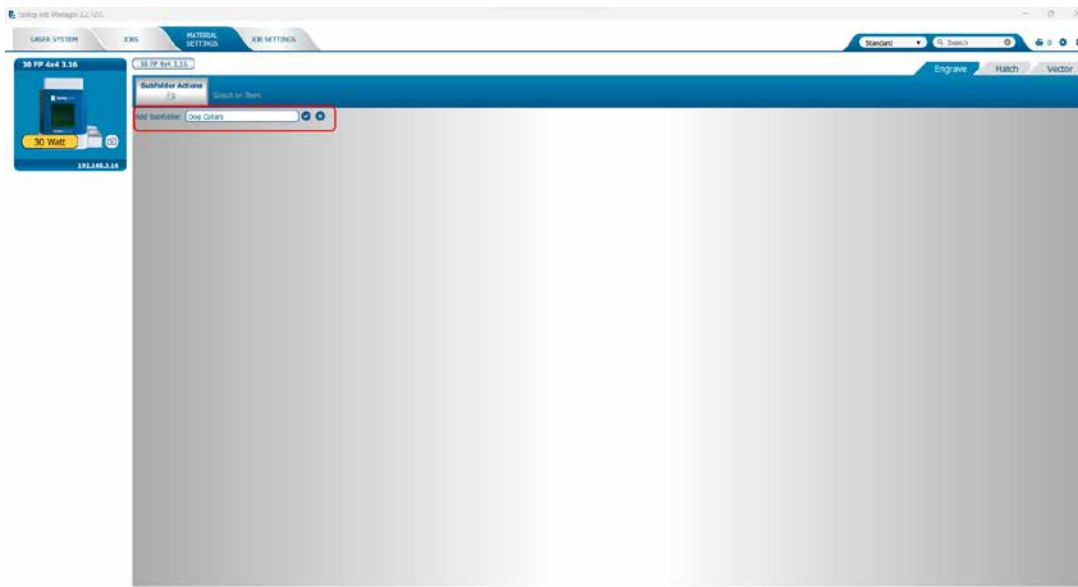

3. Now go to the Epilog Dashboard and set up the file to your preferred settings. Click on the process that has settings you want to save. In this example we have clicked on Blue. The Process box should open, then click the “Export Settings to Material” button.

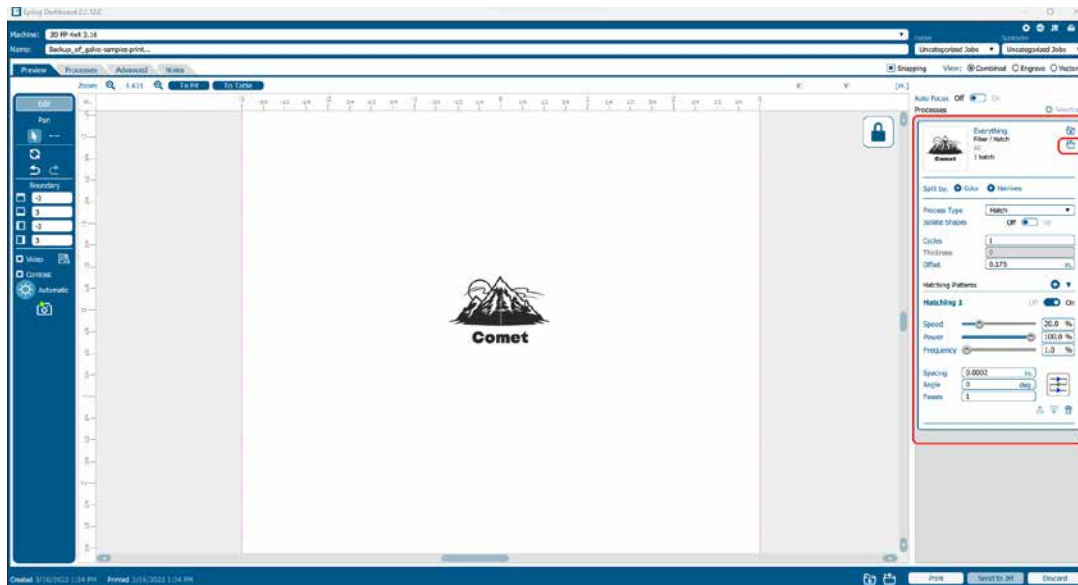

SECTION 4: THE JOB MANAGER

4. A box will appear asking you to name the Material Setting and select a folder to save it in. Fill out this information and then click "Save".

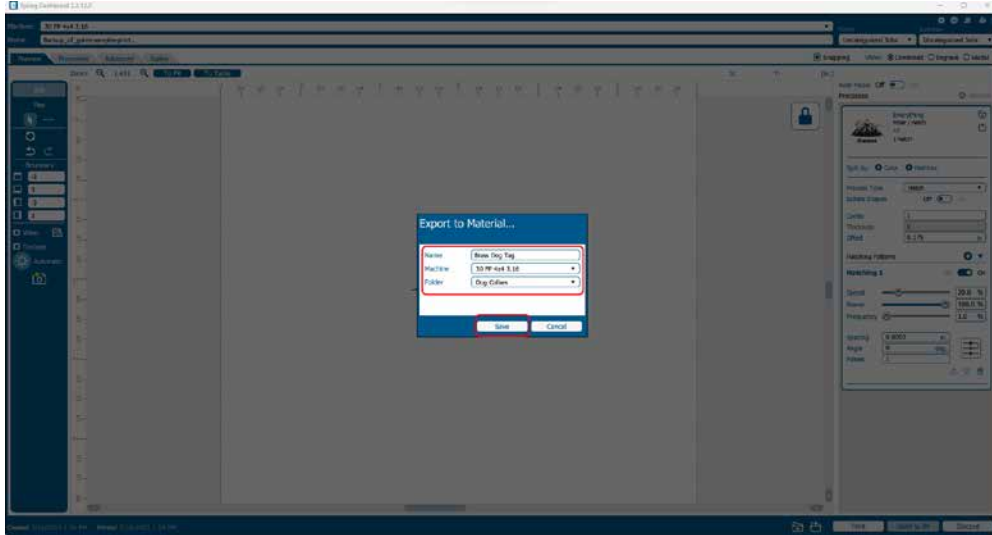

SECTION 4: THE JOB MANAGER

Importing Material Settings

1. To import previously saved settings to a new job, click on the process you want to apply the settings to. Then click the “Import Material Settings” button.

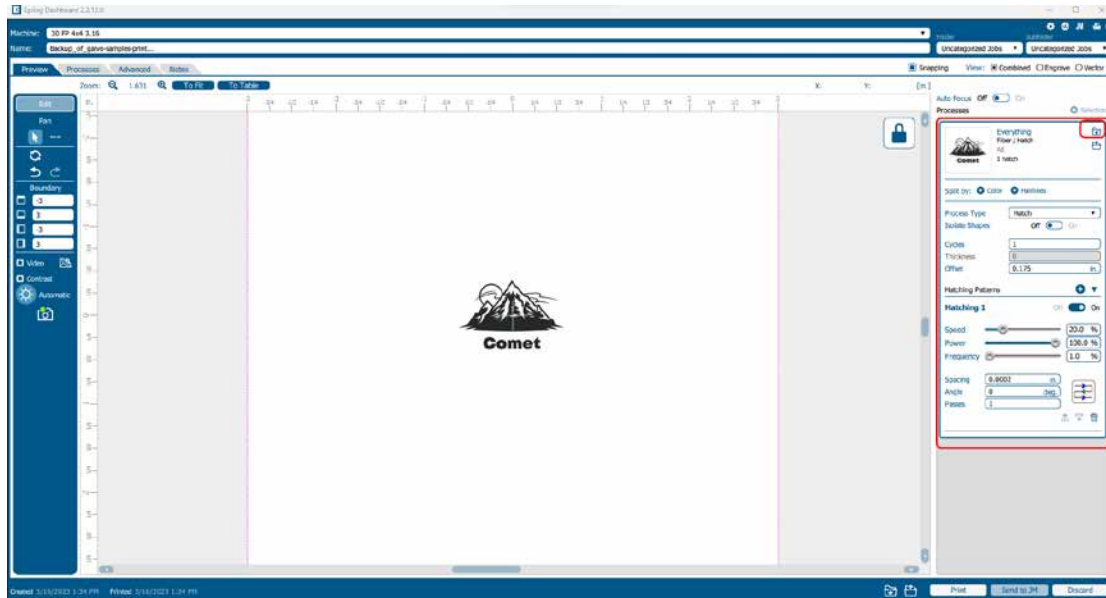

2. A box will appear asking you to select the settings you want to load into this process. Select your settings and click “Import”.

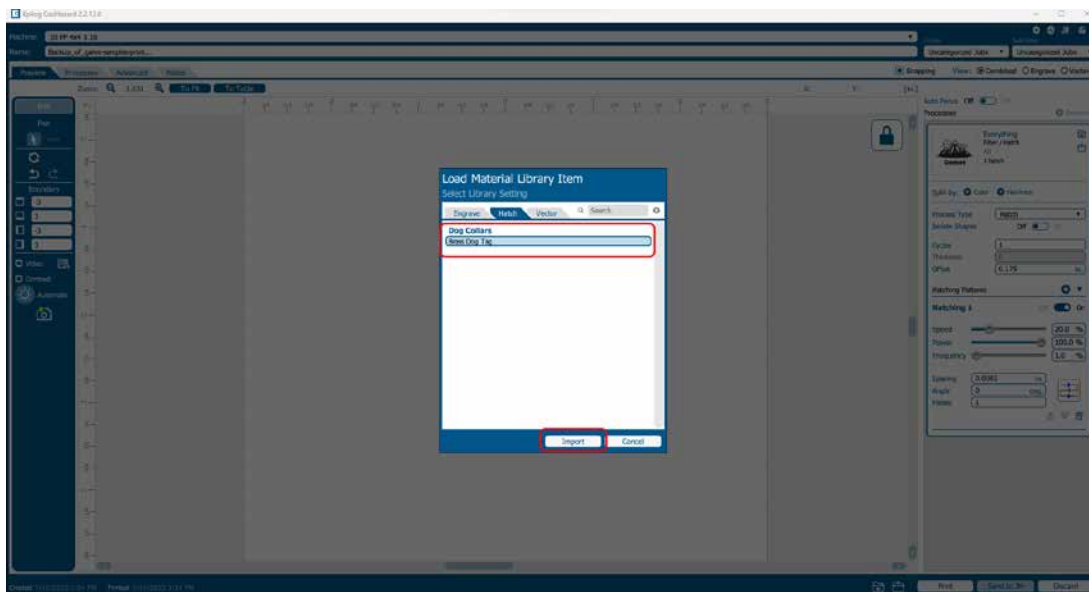

3. The material settings should load on to that process and be ready to print to the laser.

SECTION 4: THE JOB MANAGER

Job Settings Tab

The Job Settings Tab allows you to store all the information that is in a job, except for the artwork, as a file you may import into future jobs. If you have a project you run frequently that requires the same settings every time, this feature allows you to import those settings quickly.

Saving a Job's Settings

1. To save a job's settings, first open the job in the Epilog Dashboard and set up the file as you normally would to print. Once your settings are ready to save, click the Export Job Settings button at the bottom of the screen.

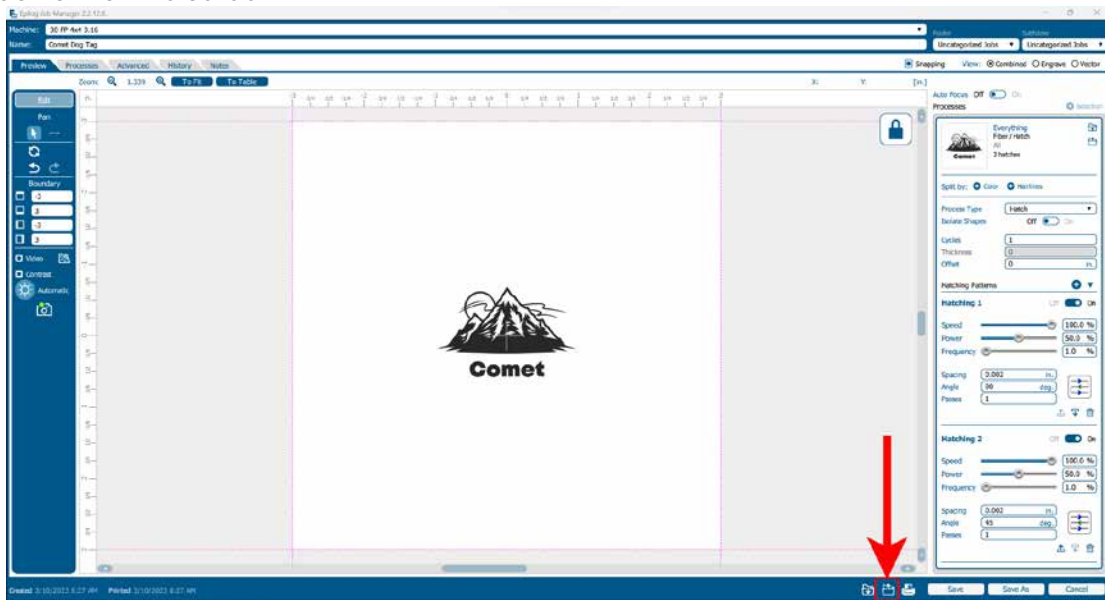

2. A box will appear asking you to name the Job Settings file and select a folder to save it in. Fill out this information and then click "Save".

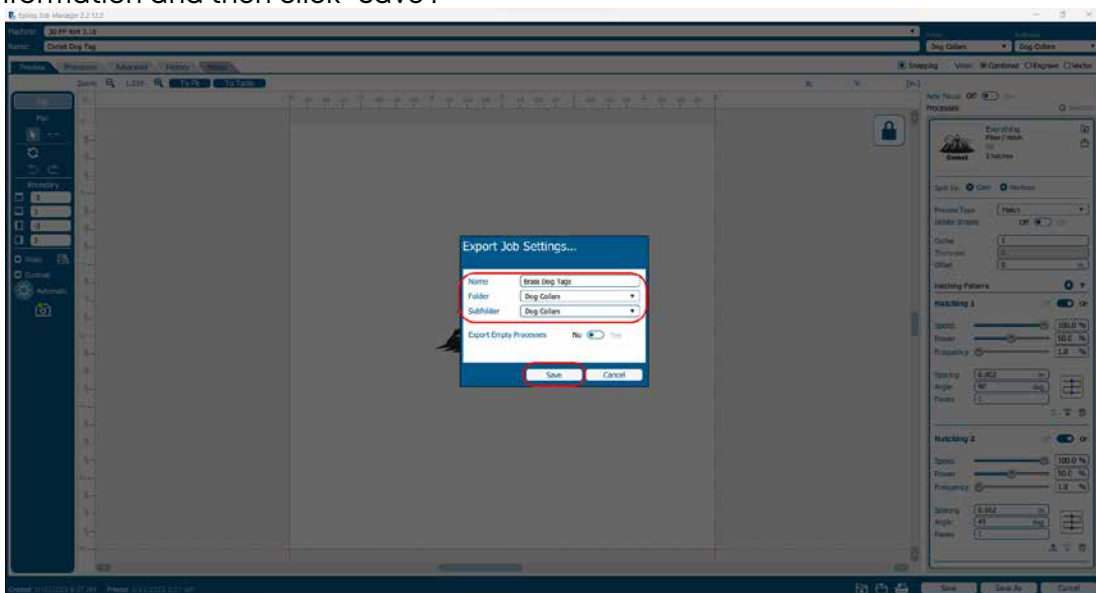

SECTION 4: THE JOB MANAGER

Importing Job Settings

1. To import previously saved settings to a new job, click the Import Job Settings button at the bottom of the screen.

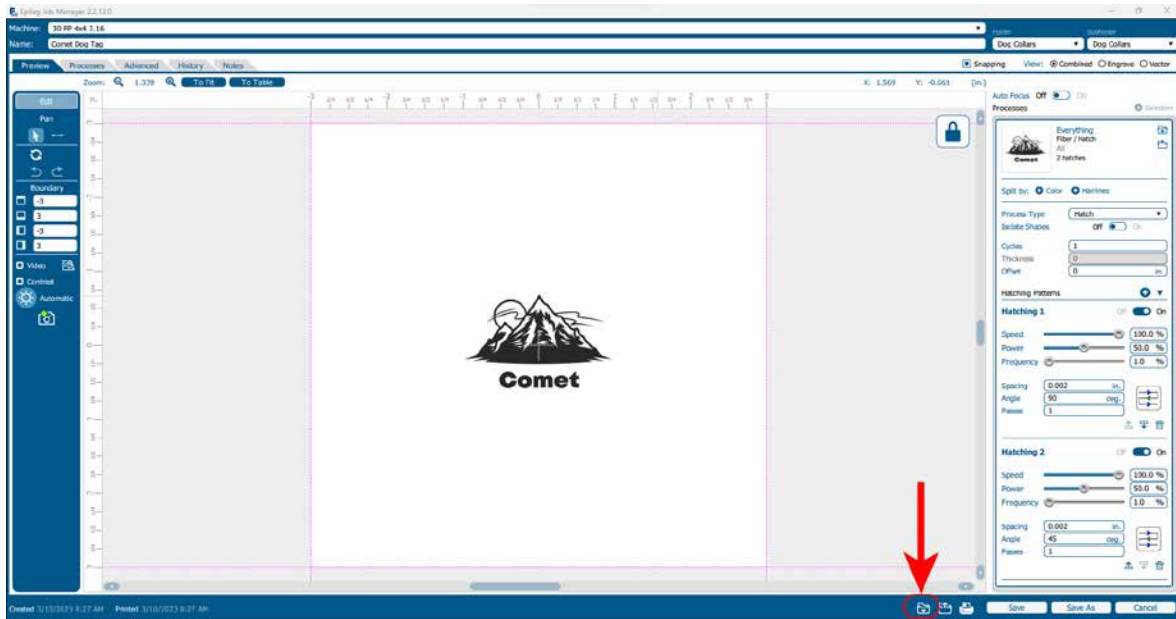

2. A box will appear asking you to select the settings you want to load into this job. Select your settings and click "Import".

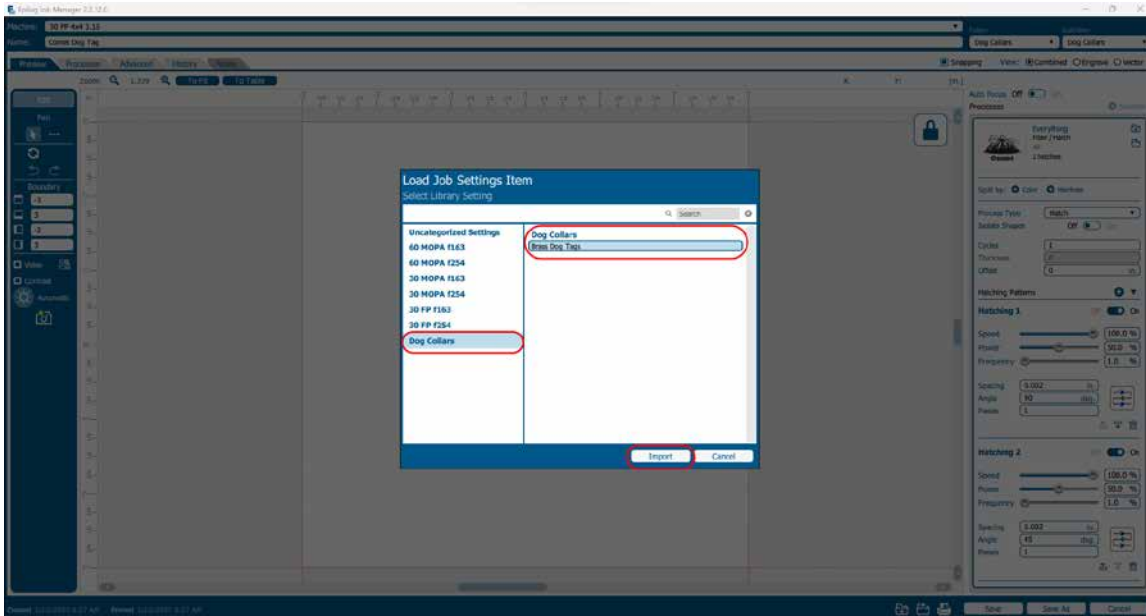

3. The job settings should load into the file, ready for printing to the laser.



Note: You may also create Job and Material settings from scratch in their respective Job Manager tabs.

SECTION 4: THE JOB MANAGER

Default Job Settings

If you are consistently using the same job settings every time you send a new job to the laser, setting your own default job settings is a useful way to save time and run new jobs quickly. This is useful when you're working with the same materials frequently that require the same Speed, Power, and Frequency/Resolution settings.

In the Job Settings tab of the Job Manager, select a job setting you have already saved. Once selected, click the check mark button in the menu above your list of job settings to set it as the default.

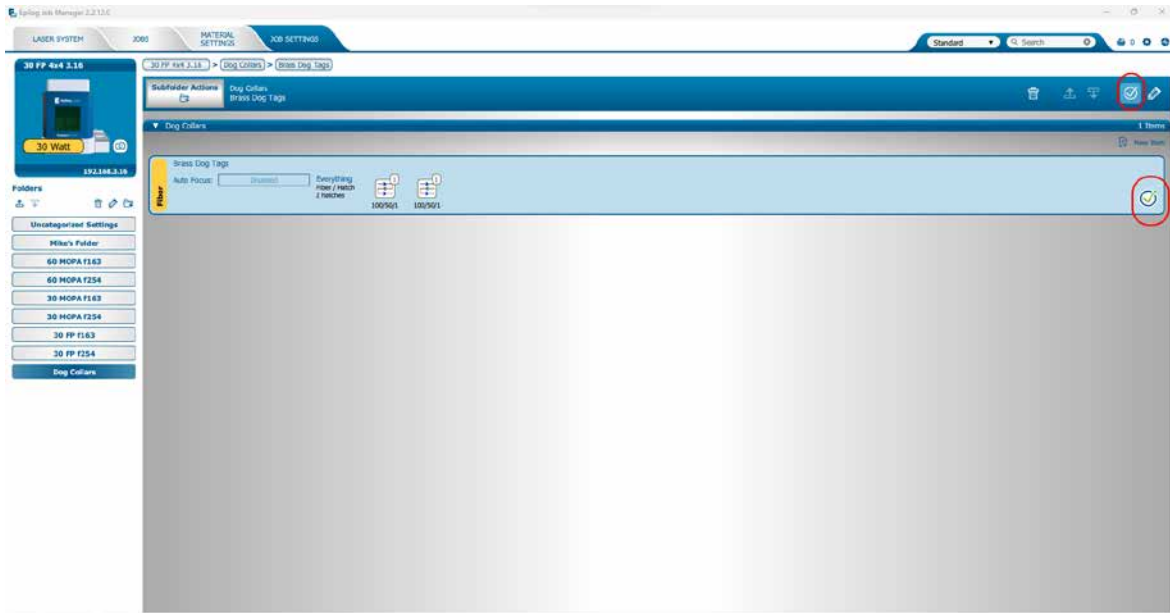

This job setting is marked with a check mark to signify that it will now be the default. Now every time artwork is printed to the Epilog Dashboard, those settings will be automatically applied, and the job will be ready to be sent straight to the laser.

To turn off the default, select the job setting that is set to the default and click the check mark button again. This will return the default job settings to the standard default.

Using the Material Setting Configurations

The Material Settings tab stores all of the suggested laser parameters like speed, power, etc. These settings were loaded based on the wattage you specified in the Laser System tab (adding your laser was the very first thing you did to start using the Job Manager).

SECTION 4: THE JOB MANAGER

To use the Material Settings that are automatically loaded in your Job Manager, go to the **Jobs** tab and **double-click on the job** you want to process.

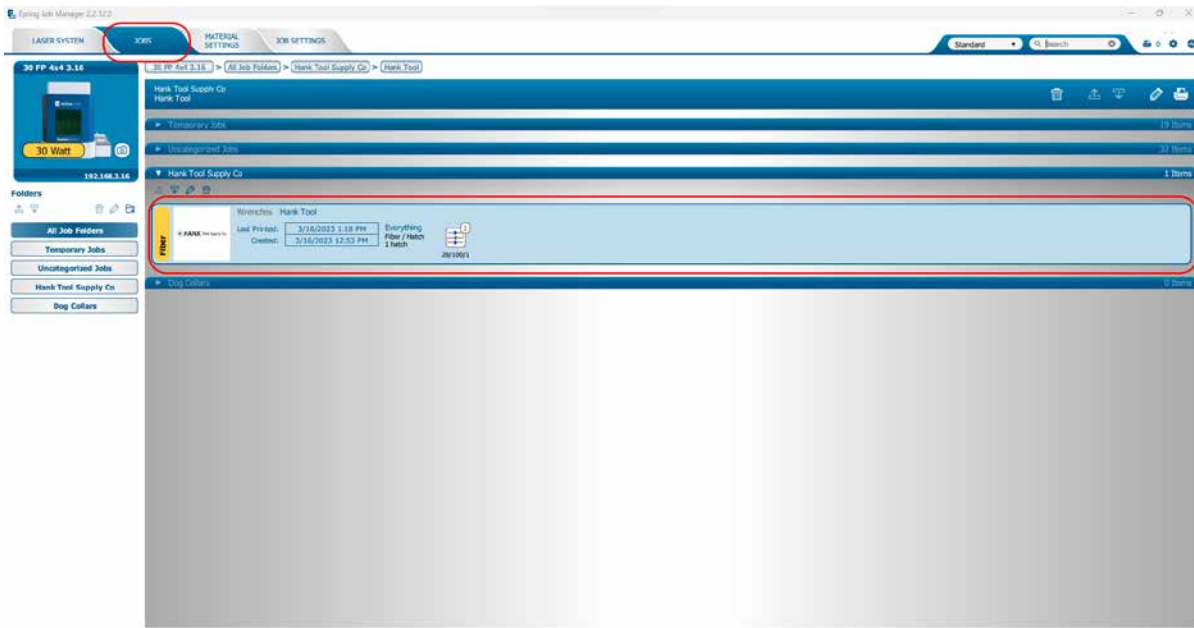

Click the **Import Material Settings** icon.

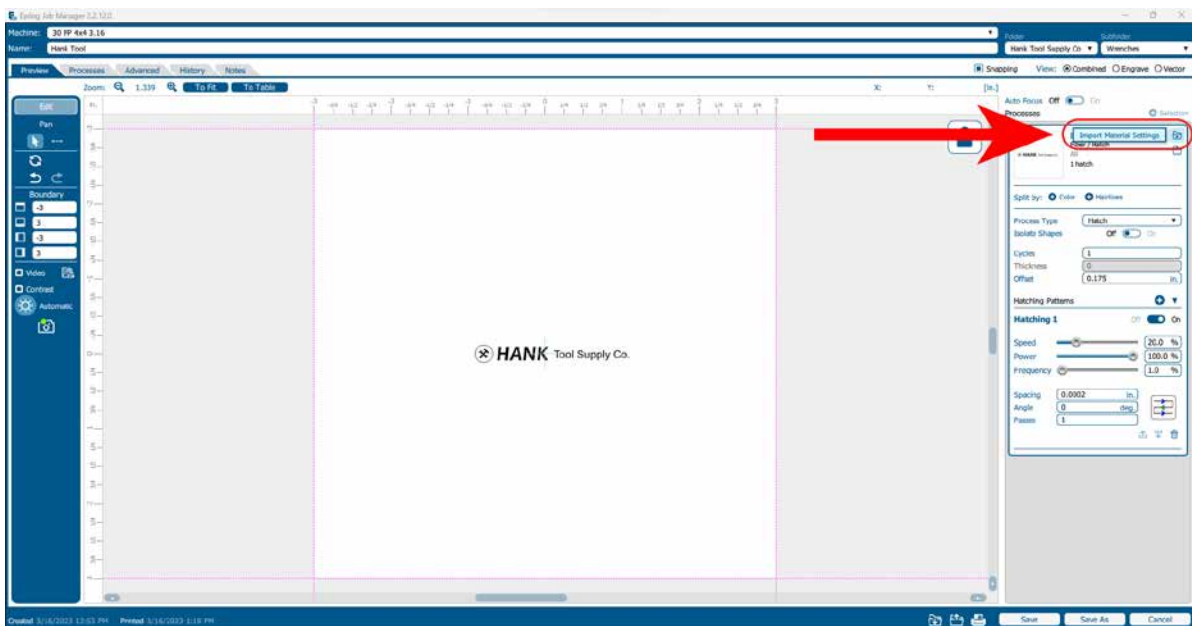

SECTION 4: THE JOB MANAGER

Navigate to the material setting you need. We have highlighted **Clipart/Text Engraving 500 DPI on Wood**. Click **Import**.

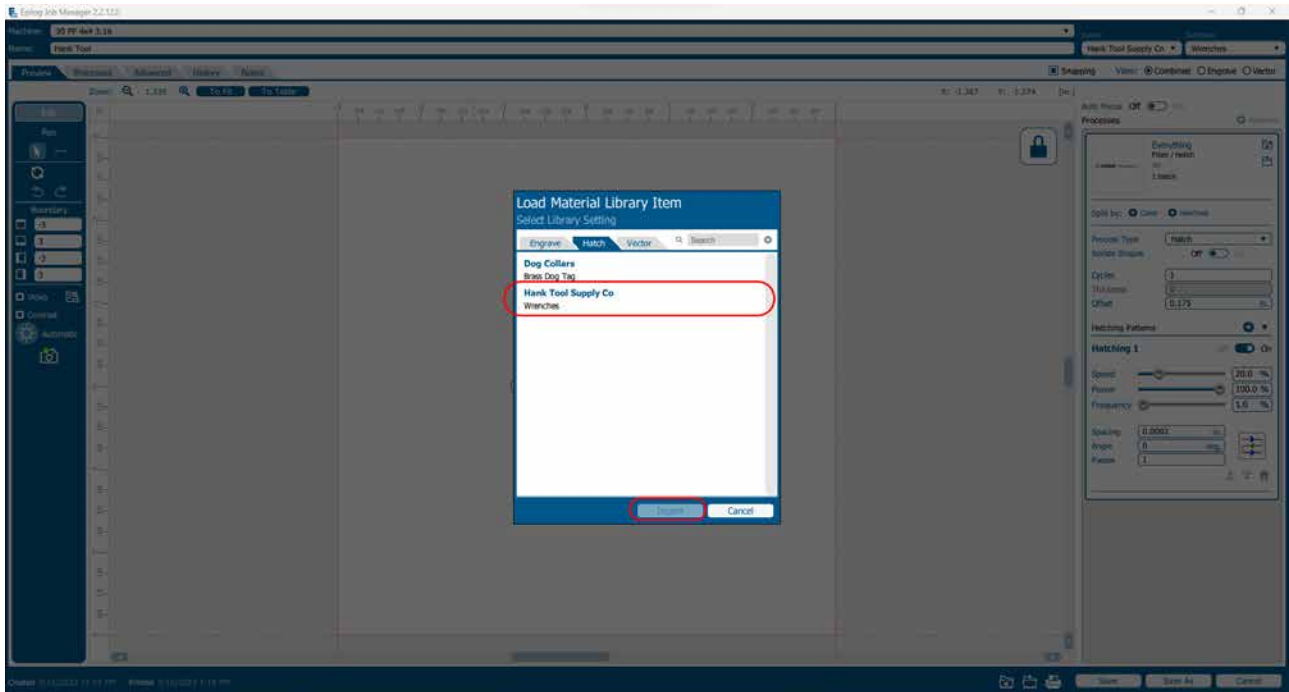

Your new settings have been automatically applied to your job file. You can now save the job file, save the job settings as a different name, or print the job.

Changing Program Settings

You can access the Program Settings by clicking on the gear at the top right of the page. On this screen you can set several different system settings, including:

Display Tab:

- **Language:** Choose from several languages.
- **Default Length Units:** Choose from inches, centimeters, or millimeters.

Dashboard Tab:

- **New Job Settings:** Uses the Epilog Default, Previous Settings, Split by Color, Split by Hairlines, or Split by Color and Hairlines. **For more information see “Dividing Your Job Into Processes” on page 73.**
- **Open Job Manager Automatically:** When “Send to JM” is clicked, and this option is On, the Job Manager will automatically be opened.
- **Discard After Printing:** When “Print” is clicked, and this option is On, the job will be discarded.
- **Auto Extend Margins:** Automatically expands printable area to the full extents of the table for new jobs.

SECTION 4: THE JOB MANAGER

Job Manager Tab:

- **Close After Saving:** When “Save” is clicked, and this option is on, the job edit dialog will be closed.
- **Close After Printing:** When “Print” is clicked, and this option is on, the job edit dialog will be closed.

Alerts Tab:

Choose when the program asks for confirmation when you delete machines, folders, subfolders, or jobs and materials.

Database Tab:

- **Backup Database:** Save a backup of all files, material settings, etc.
- **Restore Database:** Reload settings from a previous backup.
- **Compress Database:** Compress the database file to take up less space on your computer.
- **Clear Entire Database:** Delete all settings, machines and jobs from the database.
- **Clear All Jobs:** Delete all jobs in the database.
- **Clear Uncategorized:** Clear out all uncategorized jobs in the database.
- **Clear Dashboard Jobs:** Delete all queued jobs in the database.



We will be adding new features to the software often, so sign up for the Driver Update Notification list at www.epiloglaser.com/tech-support/epilog-drivers.htm.

SECTION 4: THE JOB MANAGER

Troubleshooting the Job Manager

If you're having trouble getting the Job Manager to load, or having an error that the Job Manager cannot communicate with the Dashboard, your computer's graphics card may need to be updated. To do so, follow the steps below:

1. In the Windows search bar, search for **“Device Manager”**.

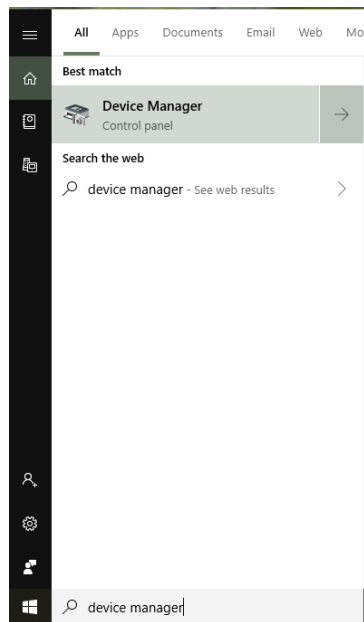

2. Once the Device Manager opens, click on **“Display Adapters”** to reveal your graphics card. Right click on the graphics card and select **“Update driver”**.

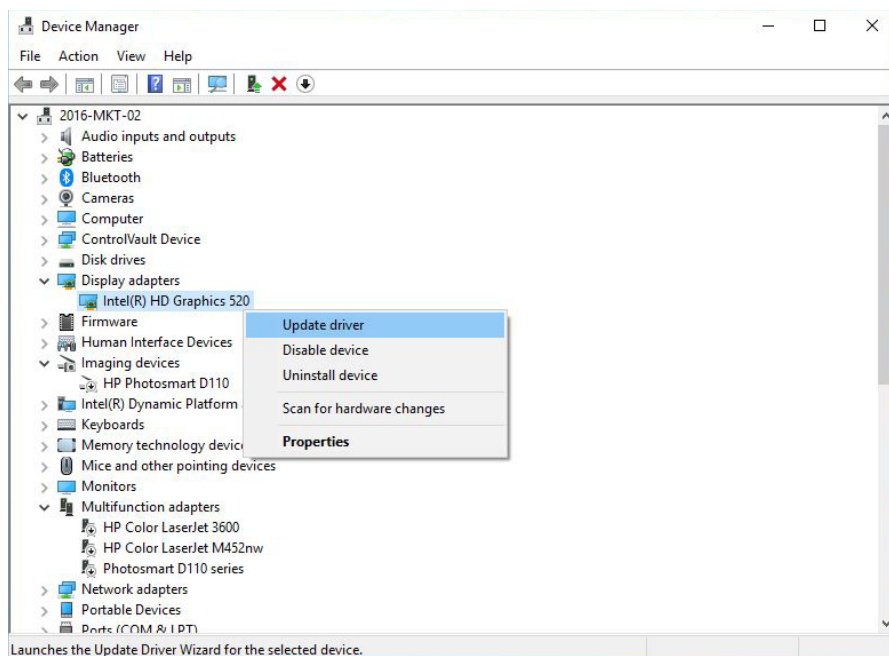

SECTION 4: THE JOB MANAGER

3. Choose which way you want to search for an update for your driver and then update the driver.

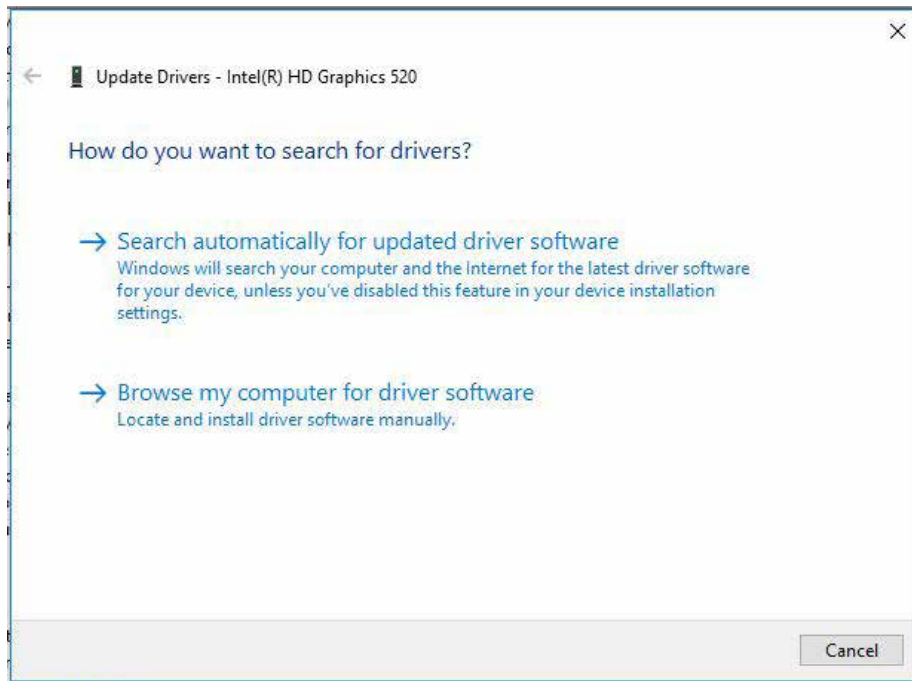

4. Restart your computer and open the Job Manager. If the problem persists, contact Technical Support.

SECTION 5: THE LASER DASHBOARD

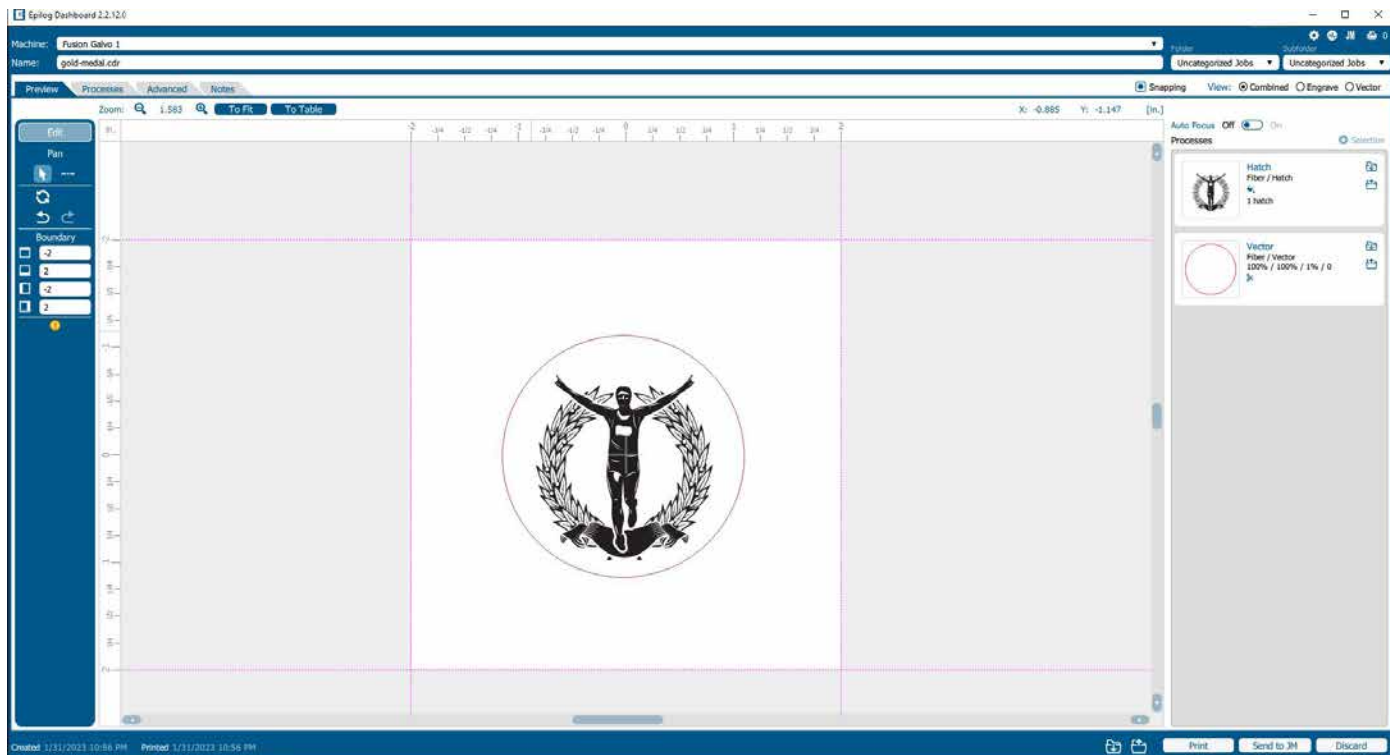

The Epilog Dashboard is your portal between your graphic file and the laser. Install your Dashboard as part of the Software Suite at epiloglaser.com/drivers. There are four main areas we'll cover to get you started:

1. Sending Your First Project from CorelDRAW and Adobe Illustrator
2. Presetting Your Cut Lines
3. Placing Artwork
4. Dividing Your Job into Processes



If you have worked with Epilog's previous print driver, you'll see some new ways that the Dashboard lets you interact with your file. It may seem different at first, but you'll quickly find that you can still use your traditional methods of printing to the laser, or use several new ones that make file setup quicker and easier!

SECTION 5: THE LASER DASHBOARD

Setting Up CorelDRAW for the Laser

If you are using CorelDRAW, first make this quick, one time change to the settings.

1. Go to Tools > Options > Global > Printing > Driver Compatibility.
2. Select **Epilog Engraver** from the drop-down list.
3. Select “**Printer can match document page sizes**”, and click OK. You’re ready to go!

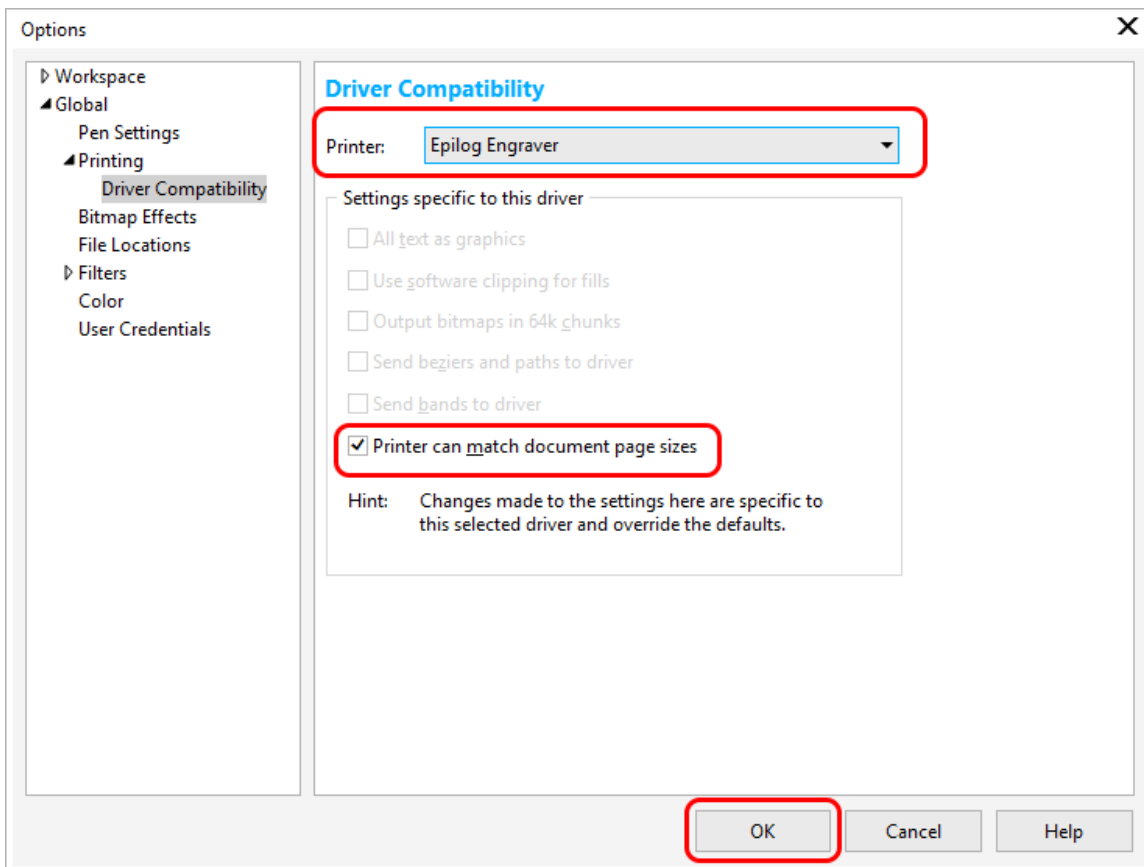

SECTION 5: THE LASER DASHBOARD

Sending Your First Project

1. When you have your file designed, print it to the laser. Choose the **Epilog Engraver** as your printer and set the **Page to Match Orientation and Size**.

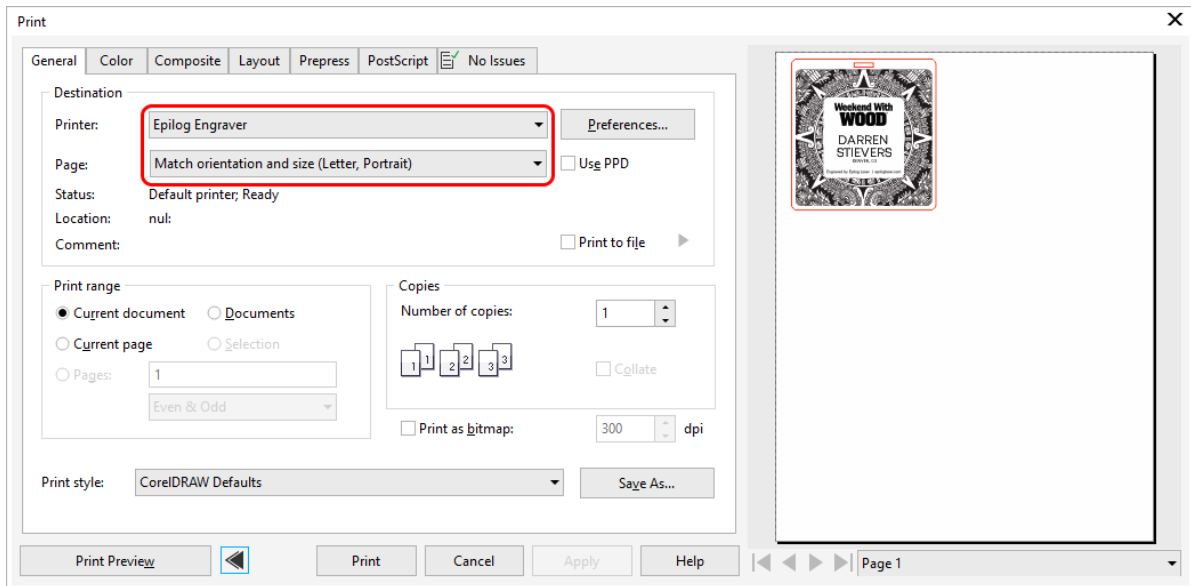

2. Click on the **Color tab** and select Output colors as **RGB**.

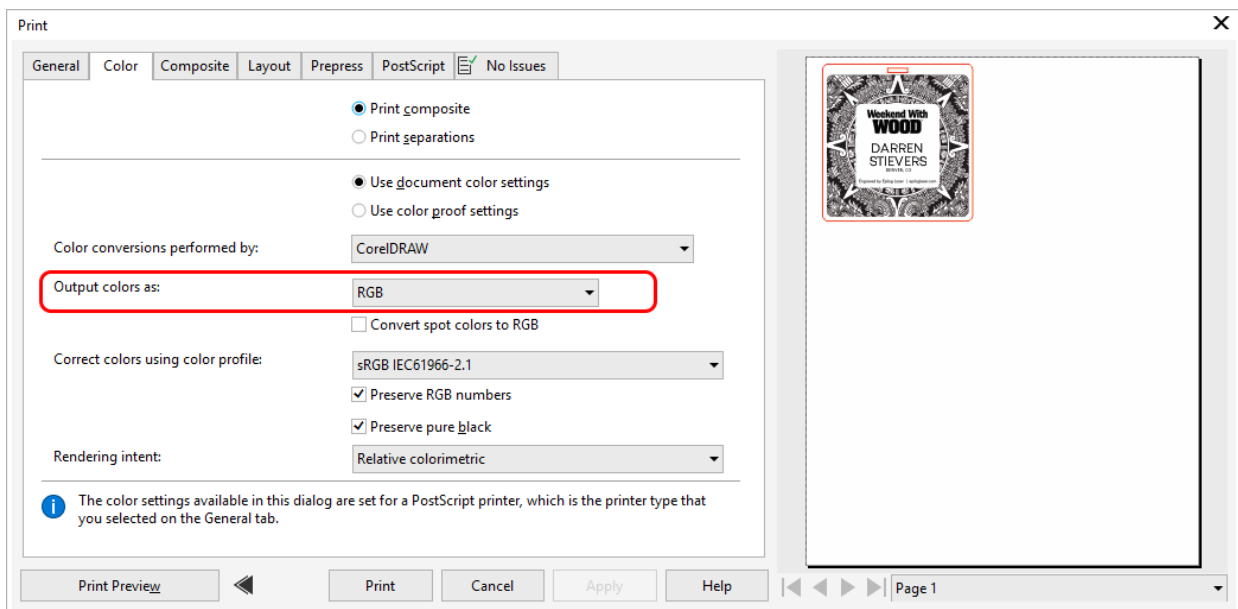

SECTION 5: THE LASER DASHBOARD

3. Click on the **PostScript tab** and uncheck “Convert True Type to Type 1”.

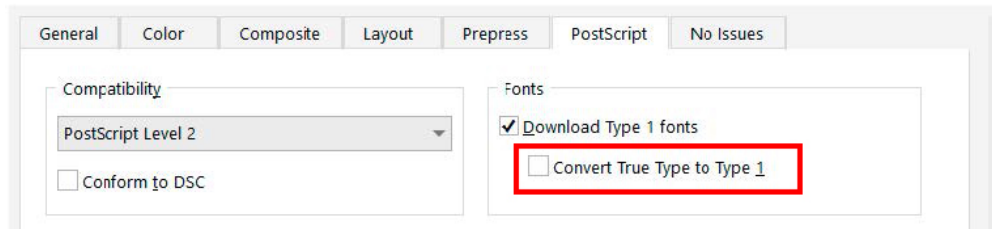

4. You will need to save these setting under the CorelDRAW Print style defaults by returning to the General tab, and clicking “Save As”.

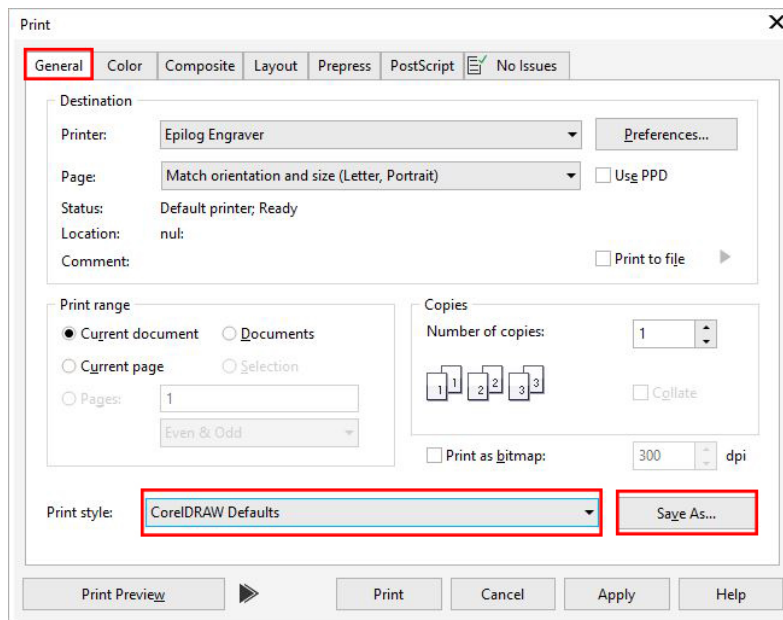

5. Save the settings and click on Apply.

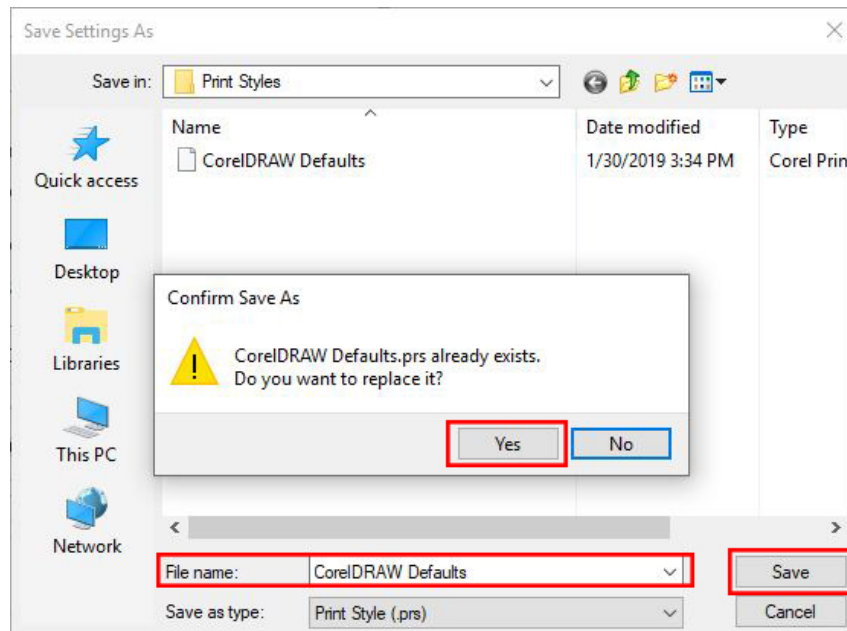

SECTION 5: THE LASER DASHBOARD

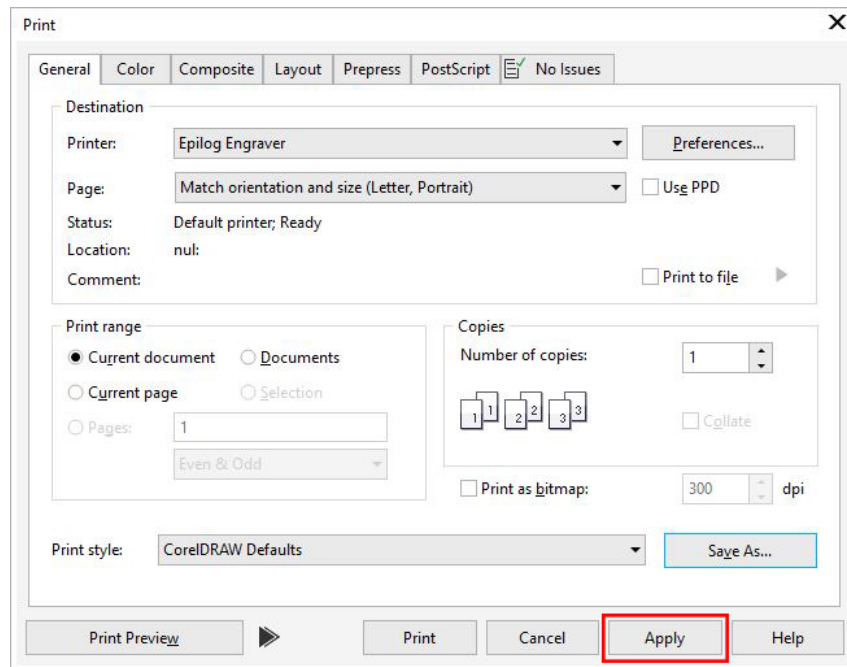

6. Then click **Print**.
7. Your file will open in the Laser Dashboard. Select **“To Fit”** to zoom in on your object.



SECTION 5: THE LASER DASHBOARD

8. On the right side of the screen you can see two processes in the process list: **Hatch** and **Vector**. These layers automatically separated because we set the line width of cut lines to .003" (0.077 mm) or thinner).

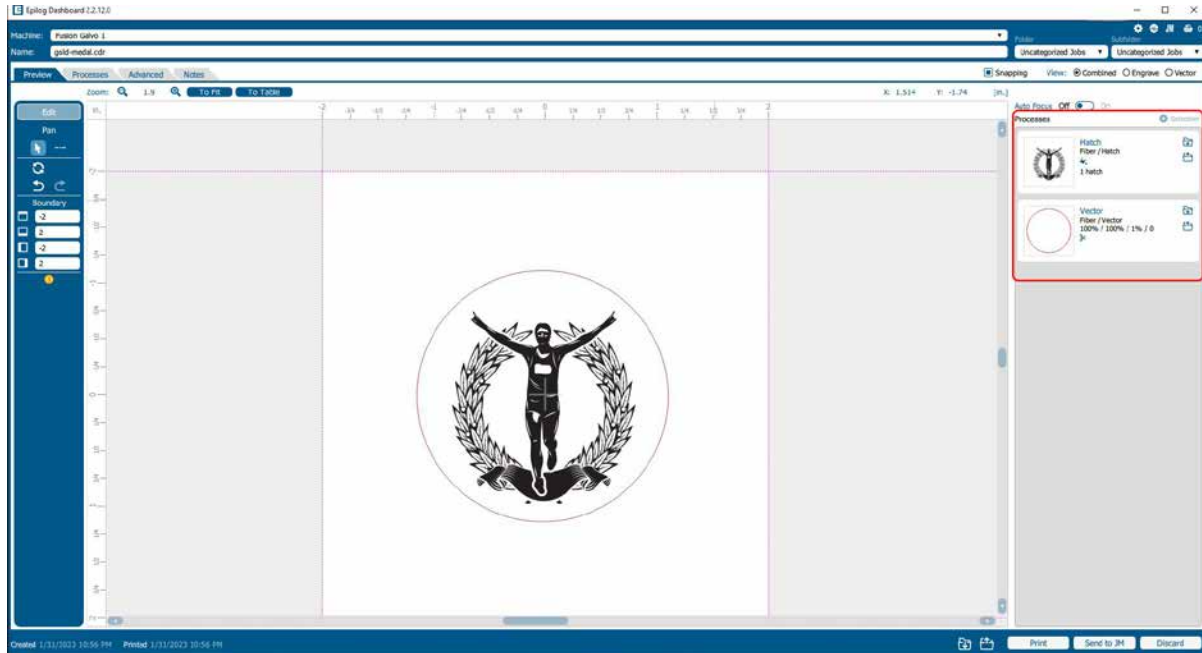

You can set the Dashboard to automatically separate vector lines by line thickness, color, or no action.

SECTION 5: THE LASER DASHBOARD

Setting Up Adobe Illustrator for the Laser

If you are using Adobe Illustrator, you will need to use the following settings when printing to the Software Suite.

1. In Illustrator click File > Print when you're ready to send your artwork to the Software Suite.

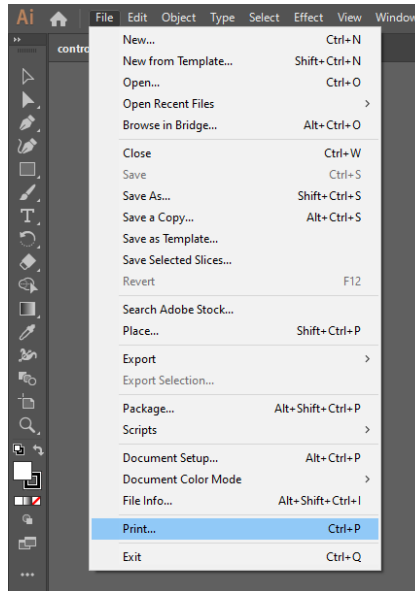

2. In the print settings, under Printer select "Epilog Engraver", then set the Media Size to "Custom". Doing this will automatically feed the correct page size to the Epilog Engraver driver. Then click "Print" to send your job to the Epilog Software Suite.

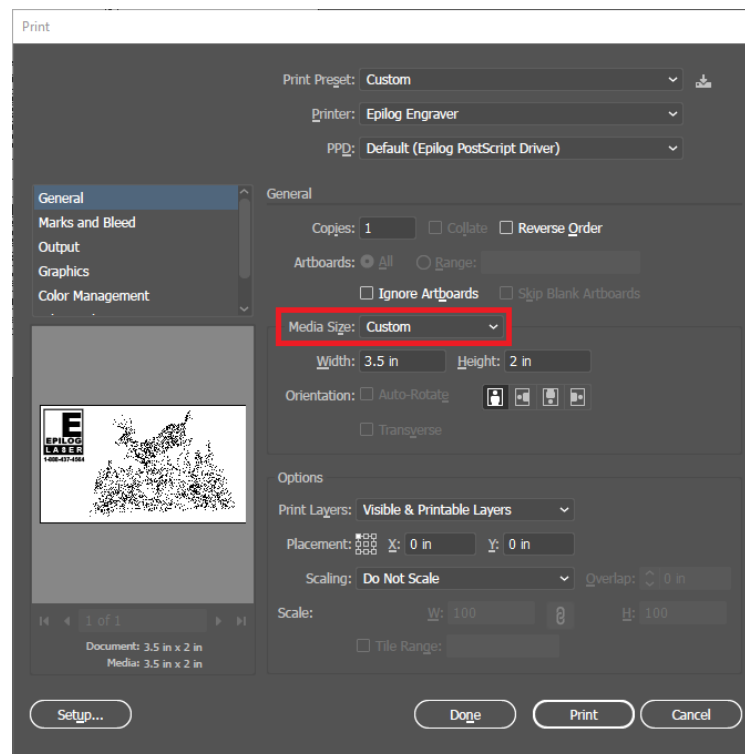

SECTION 5: THE LASER DASHBOARD

Sending Vector Marking Paths from Illustrator

To automatically designate a path as a vector cut, set the line thickness to a 0.1pt thickness or less. To set the stroke thickness, select the outlined graphics item and view the properties tab on the right-hand side of the screen.

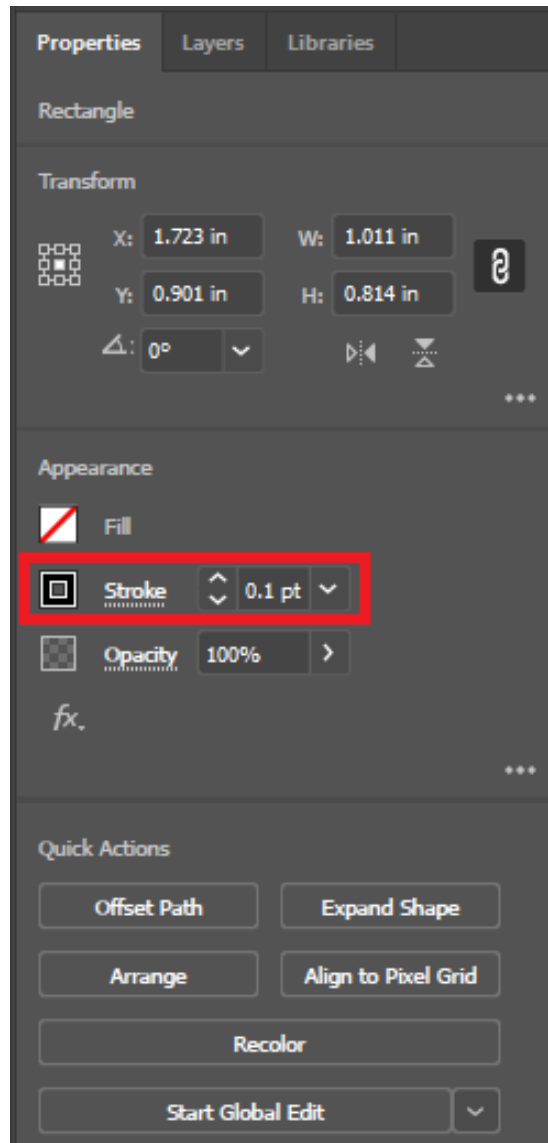

SECTION 5: THE LASER DASHBOARD

Dashboard Settings

Auto Focus

Select Auto Focus when you want to use the machine's Auto Focus capabilities. You can choose between **On** or **Off**. This enables the "Thickness" setting for each process. **For more information about Auto Focus, see "Auto Focus" on page 104.**

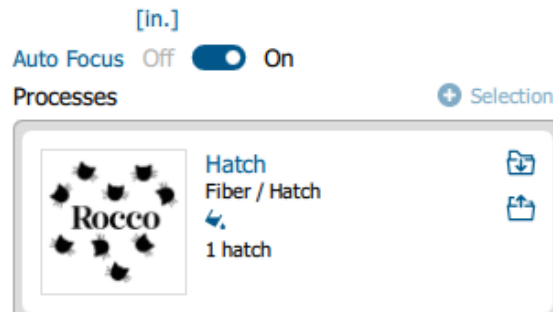

Thickness

For the Thickness option, measure the thickness of the material you are using to engrave or cut, and input the number into the Thickness box **under each individual process**. The table will automatically move up or down so that the top of your material is the correct distance from the bottom of the focus lens, right before running the job.

Off

This is the default option for Auto Focus. If "Off" is selected, the table will not move up or down when the job starts. When set to "Off", you must use another method of focusing, since the table must be in focus before running a job.

You may also focus the table using the Manual Focus Gauge.

SECTION 5: THE LASER DASHBOARD

3. With the Engrave process selected, we can now adjust the settings for this process.

- **Process Type:** Click on the process name (“Hatch” or “Engrave” in this example) to rename the process.
- **Split By:** Select either “Color” to move every color in the graphic to separate processes (useful for color mapping), or “Hairlines” to manually move .003” (0.077 mm) or thinner vector lines to a separate process.
- **Merge With:** Merge the current process with another process layer. For more details, see “Merging Processes” on page 75.
- **Process Type:** Choose if you want the process to be “Off” (ignored by the laser), “Engrave”, “Hatch”, or “Vector”.

Setting the process to **Engrave** will engrave all graphics and lines, regardless of line width. Setting the process to **Vector** will ignore any raster graphics and only cut all vector lines in the process.

- **Isolate Shapes:** All individual shapes are hatched separately. Turning off the “isolate Hatch” toggle will typically speed up runtime.
- **Resolution** can be set anywhere between 75-1200 DPI. For more information about resolution, see “Resolution” on page 100.
- Set your **Speed** and **Power**. **Frequency** will only be active when the process type is set to Vector. For more information, see “Frequency” on page 83.
- **Wave:** This setting controls the energy output of the laser. Waveform can be set between 0 and 15, 0 producing the shortest pulse duration and 15 producing the longest pulse duration. A longer duration pulse produces a higher energy individual pulse.
- **Beziers:** This setting fine-tunes how the path of the laser follows each point in a curve when vector cutting. This setting will only appear if you are running a vector process.
- **Dithering / Vector Sort:** The dithering drop-down will appear for Engrave processes, and Vector Sort for Vector processes.
- **Unidirectional:** Set engraving to run left-to-right only
- **Precision Sync:** Enhances engraving quality, but increases run time, by making an invisible box around the engraving. This means that every engraving line in this process will have the same stroke length.
- **Cycles:** How many times to repeat this process.
- **Laser:** This will only appear if you are working with a Dual Source machine. Choose between the CO2 and fiber laser for each process.
- **Thickness:** Measure the thickness of the material and input the number into the Thickness box. Active only when Auto Focus is enabled to “Thickness”.
- **Sweep / S-Sweep:** This mode keeps the laser on when moving from line to line within the engraving. Instead of a series of discreet lines, the S-Sweep produces an S shaped pattern as the Galvo changes directions from one connected line to another.
- **Offset:** Offset allows you to focus at any point above or below the surface of your material. For more information, see “Offset” on page 83.

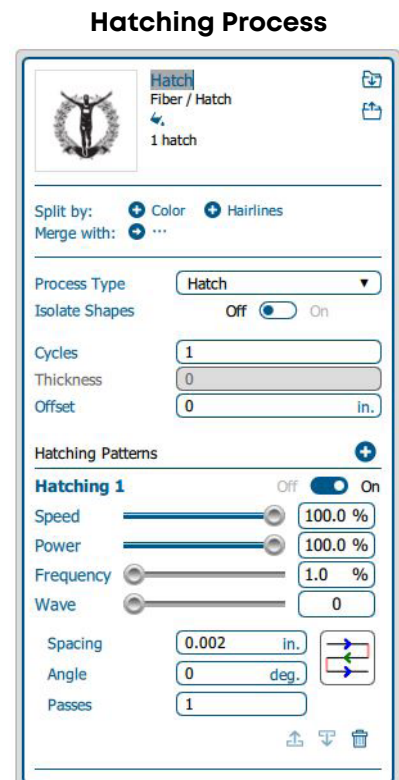

Engraving Process

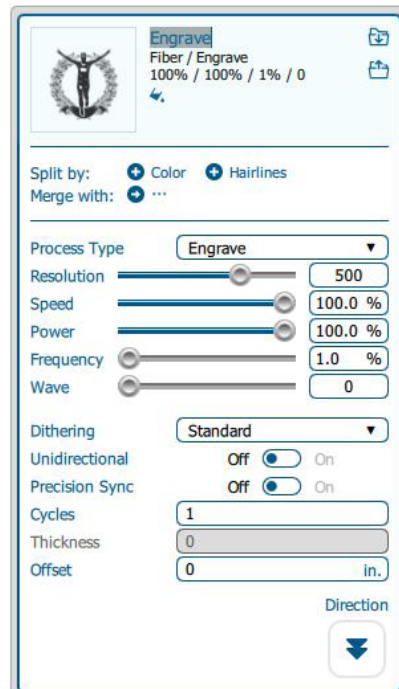

SECTION 5: THE LASER DASHBOARD

- **Direction:** Choose whether you want the engraving to start at the bottom of your piece or the top. For more information, see “**Engrave Direction**” on page 82.
4. Repeat this set up with the Vector process layer.
 5. Print the file to the laser.

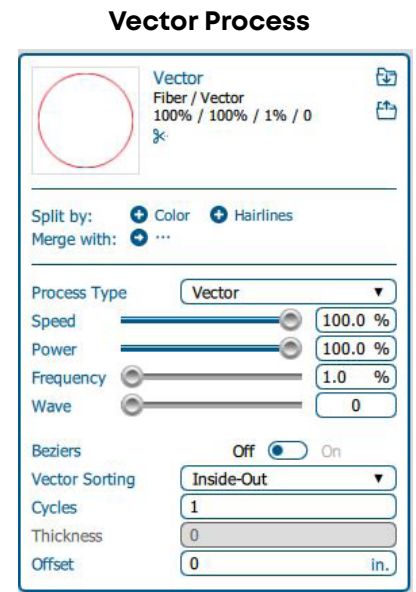

Presetting Your Vector Lines

Although you can select any vector line in the Dashboard and set it as a vector line, there are several ways in the Dashboard to preset your vector lines to save you time.

Click the Settings icon  in the Dashboard and go to the Dashboard tab. Choose between New Job Settings:

1. **Previous Settings:** Use the settings from the last job sent to the laser.
2. **Split by Color:** Automatically split all processes by colors. This is helpful when using color mapping to set different settings to different colors in your artwork, or if you always set your cut lines to a specific color.
3. **Split by Hairlines:** Automatically split all thin vector lines (line thickness set to .003” (0.077 mm) or less).
4. **Split by Color and Hairlines:** Automatically split files by both color and line thickness.

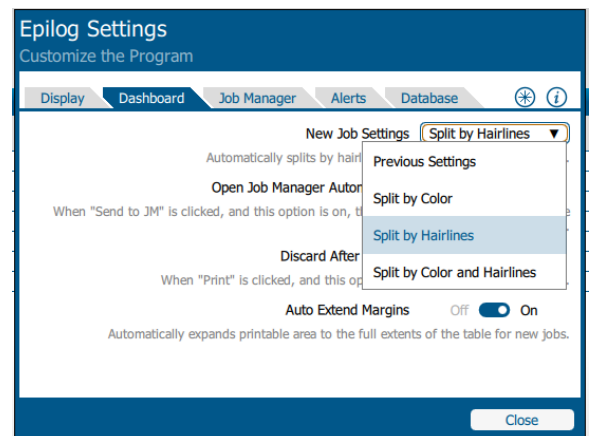

By setting the Dashboard to identify your vector lines every time you are setting up a file for print, you will find the process to be quick and easy whenever you print a new job to the Dashboard!

SECTION 5: THE LASER DASHBOARD

Placing Your Artwork

With the Laser Dashboard, you can move your image anywhere on the page to line up with your material on the table. There is no need to precisely place your artwork in your design software, because you can align it with your material using the live camera system on the Fusion Galvo.



For the most accurate results, we recommend placing your material as close to the center of the camera as possible.

- **Edit:** You can click on the file and move it wherever you would like on the table.
- **Pan:** Change to Pan mode to move around the table without moving the graphic's position on the table. You may also center-click and drag, or hold down the space bar to activate Pan mode.
- **Selection Mode:** The default mode for selecting your artwork and setting up your job. This is selected when the cursor arrow icon is highlighted.
- **Guideline Mode:** When this is selected you can create non-printable guidelines that help fine-tune artwork placement. **For more information, see "Guidelines" on page 83.**
- **Reset:** Reset the entire file back to its original status when printed to the Dashboard. This will also reset all laser parameters such as speed and power settings.
- **Undo / Redo:** Undo one change, or redo one change.
- **Group / Ungroup:** The file will initially appear grouped. If you want to move individual sections of the file, with the graphic selected click the ungroup icon several times until all items are ungrouped.
- **Boundary:** This is the working boundary the laser will recognize. It will ignore any graphics outside this boundary area.



SECTION 5: THE LASER DASHBOARD

Dividing Your Job Into Processes

When you have your job in the Dashboard, there are several ways to split your project into separate processes.

Split by Hairline

When you print your file to the laser, you can manually select to split your processes by hairline.

1. Click on the process and select **“Split by Hairlines”**.
2. All hairline vector lines will be grouped into a separate process.

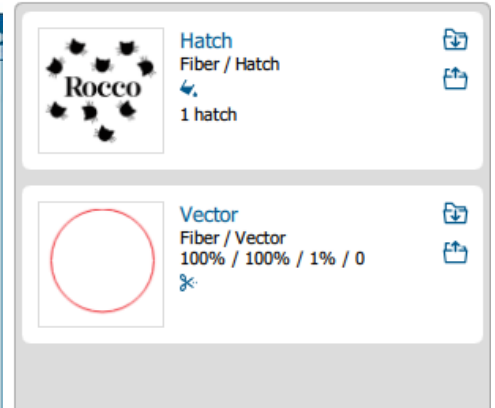
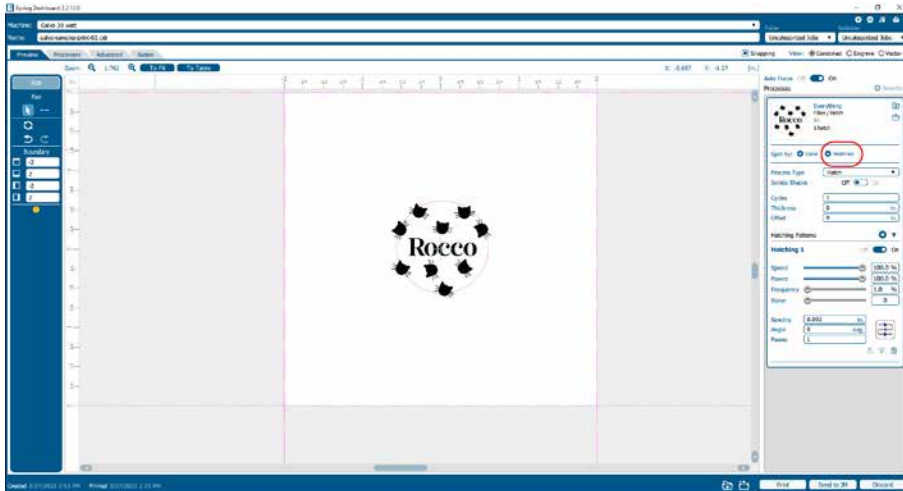

SECTION 5: THE LASER DASHBOARD

Split by Selection

After you have ungrouped your artwork, select a portion of your artwork you want to separate into its own process and select “+ Selection”. In this example we have moved the text into a separate process from the other graphics, letting us adjust the speed and power settings for just that portion of the engraving.

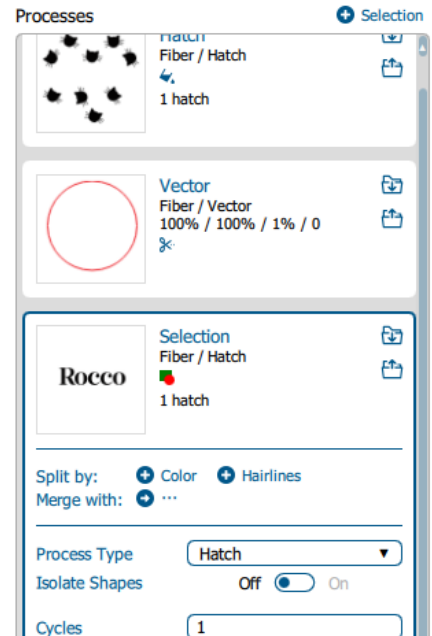
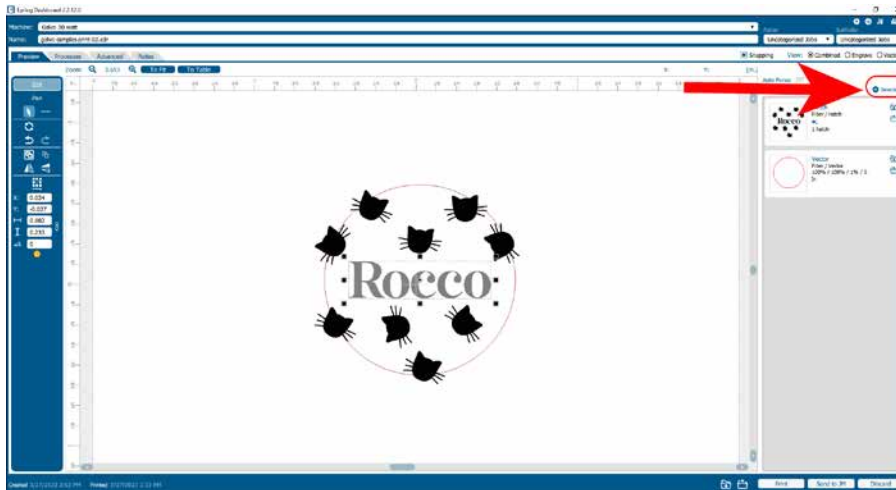

SECTION 5: THE LASER DASHBOARD

Merging Processes

If you want certain processes to be engraved at the same time with the same settings, you may merge them into one process. Click on the process you want to merge with other processes, then click on the icon next to “Merge with”.

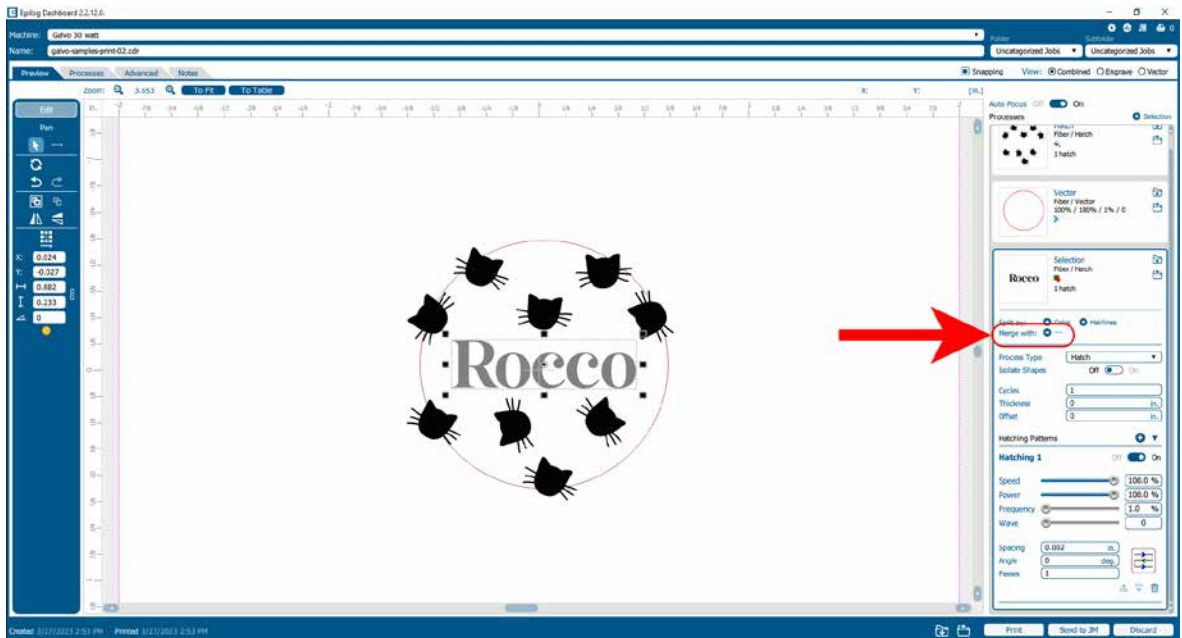

A list of processes will drop down, select a process to merge with by clicking on it.

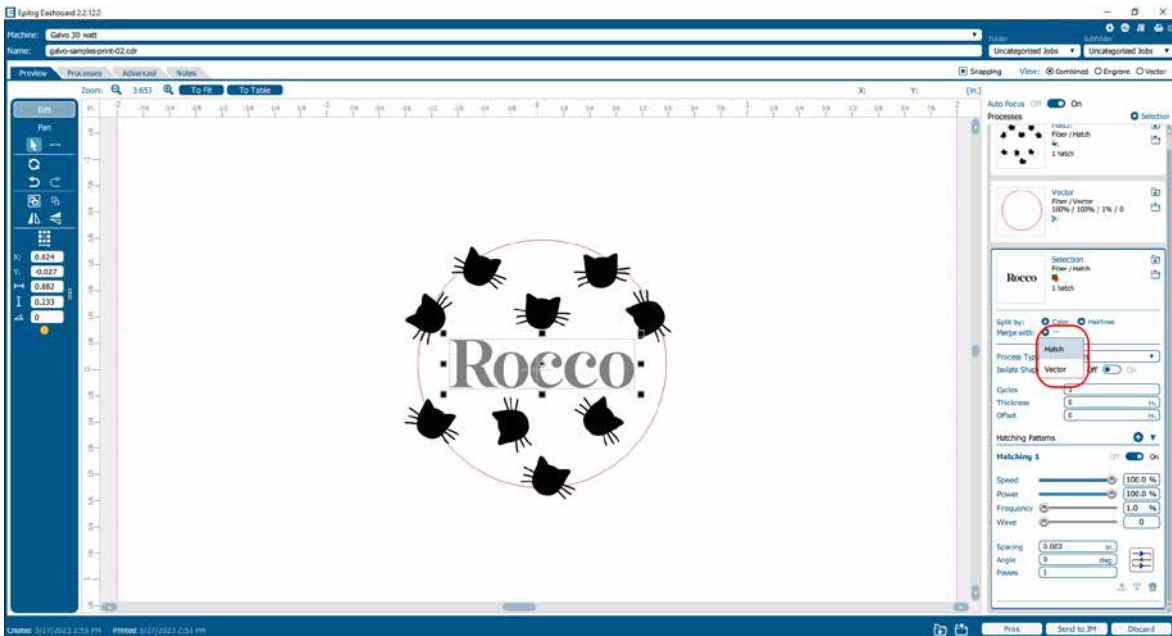

SECTION 5: THE LASER DASHBOARD

If you want to merge multiple processes all at once, hold down **“Ctrl”** on your keyboard before clicking on multiple processes in the list.

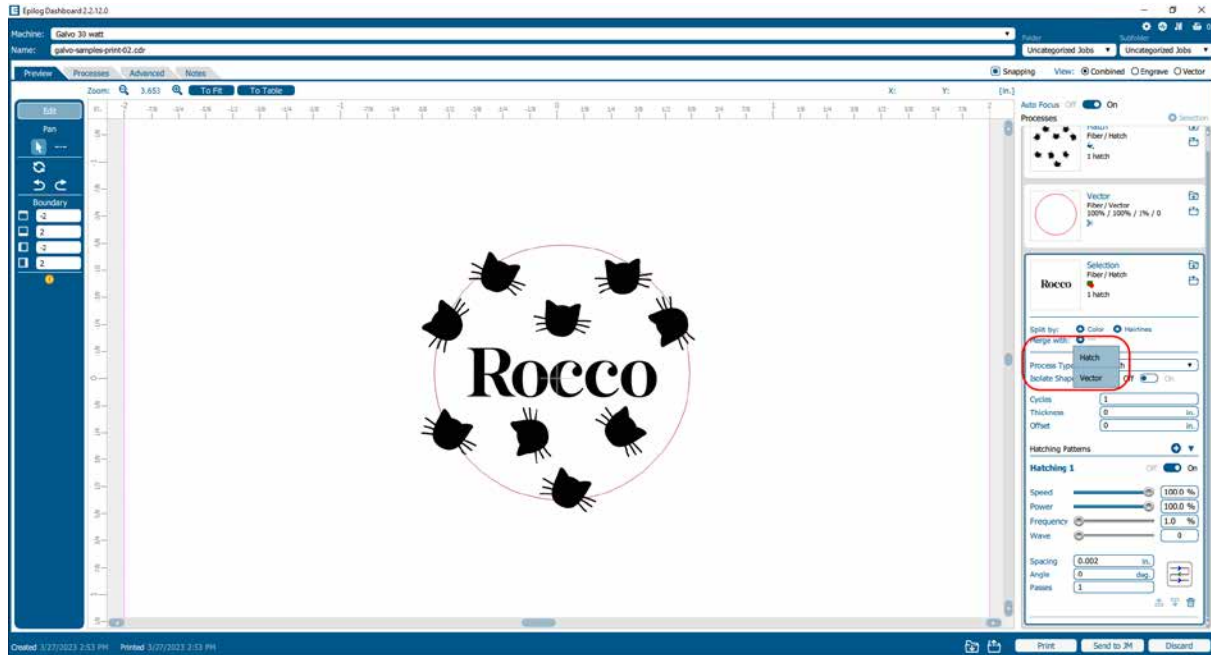

Once you let go of the **“Ctrl”** button, all of the processes should be merged together as one process.

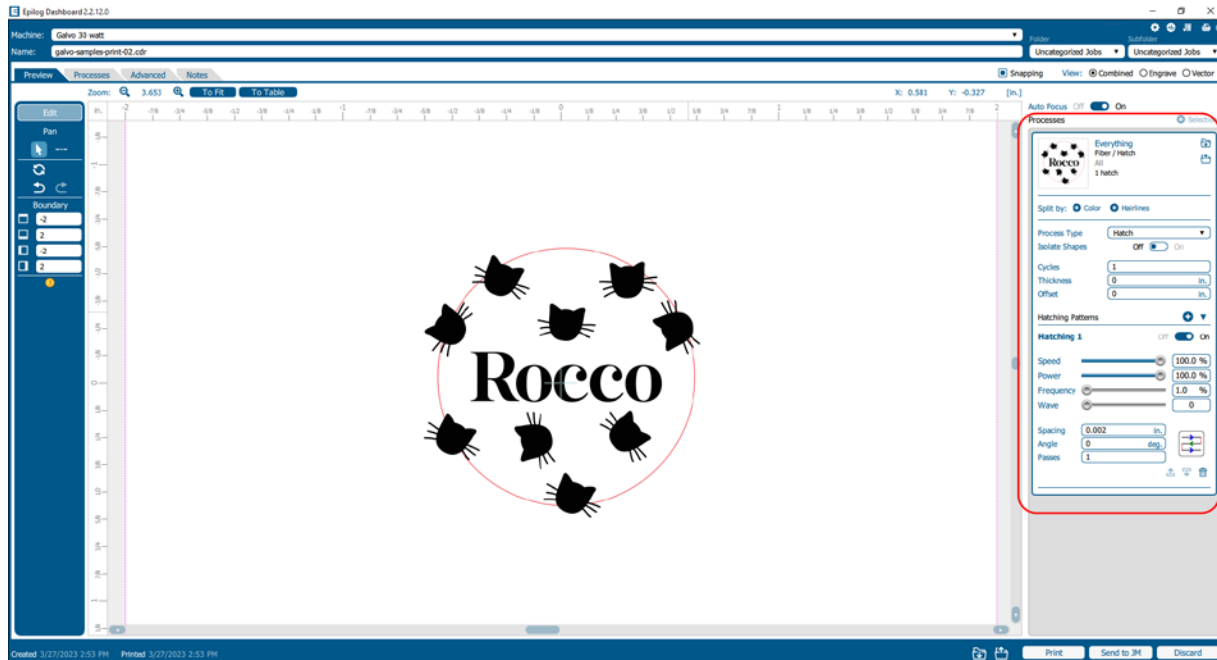

SECTION 5: THE LASER DASHBOARD

Editing Artwork with Live View

Occasionally you may want to edit your engraving artwork to fit a uniquely shaped object. With the IRIS™ Camera on the Fusion Galvo, you can copy the live preview image of your engraving piece and open it up in your preferred graphic software. From there you may adjust your graphic accordingly to the shape of your engraving piece. In this example we will create a custom curve for text to follow.

1. First, place the object you want to engrave on the engraving table.
2. Focus the table height to your workpiece.
3. Once the live preview of the table appears in the Dashboard, click on the **“Copy Background Image”** button.

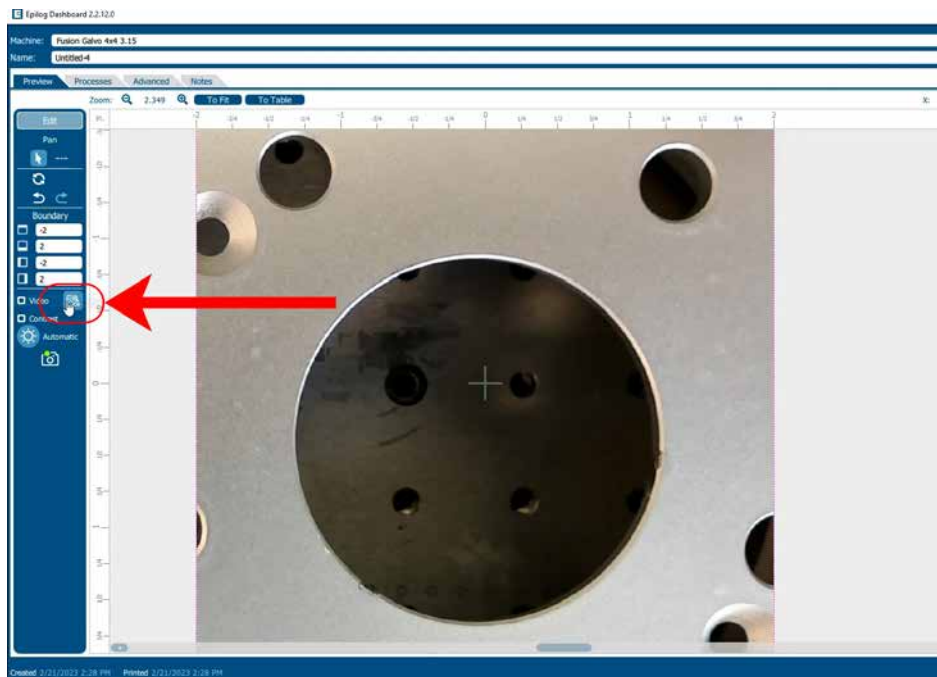

4. Open up your preferred graphic software and paste the image into a new document, with the table size as the dimensions of your document. In this example we used Corel Draw with the Fusion Galvo F163 Lens, so our document size is 4" x 4".



Note: In CorelDraw you can lock the background image into place by right clicking on the image and selecting **“Lock Object”**.

SECTION 5: THE LASER DASHBOARD

5. To make our artwork follow the shape of the inner circle, we will need to trace the area we want to place the text with the Circle shape tool.

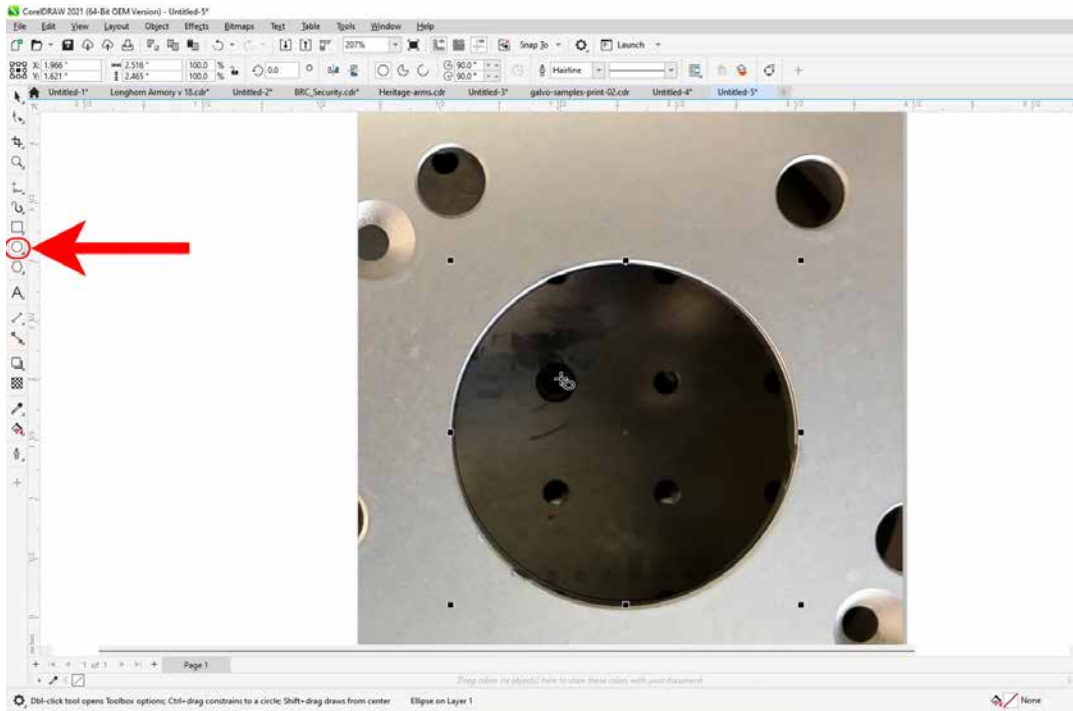

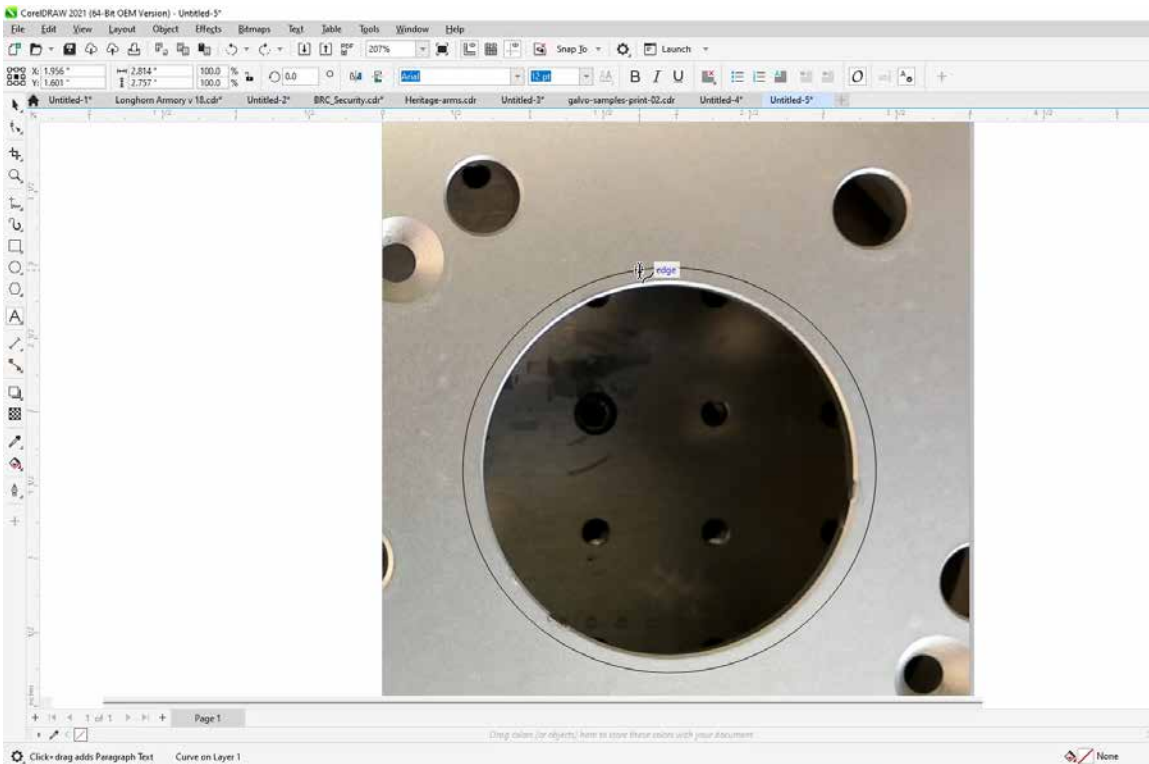

6. Once the shape is where you want it, select the Text tool and move the mouse over the circle until you see a curved line icon appear. Click on the shape when this icon appears.

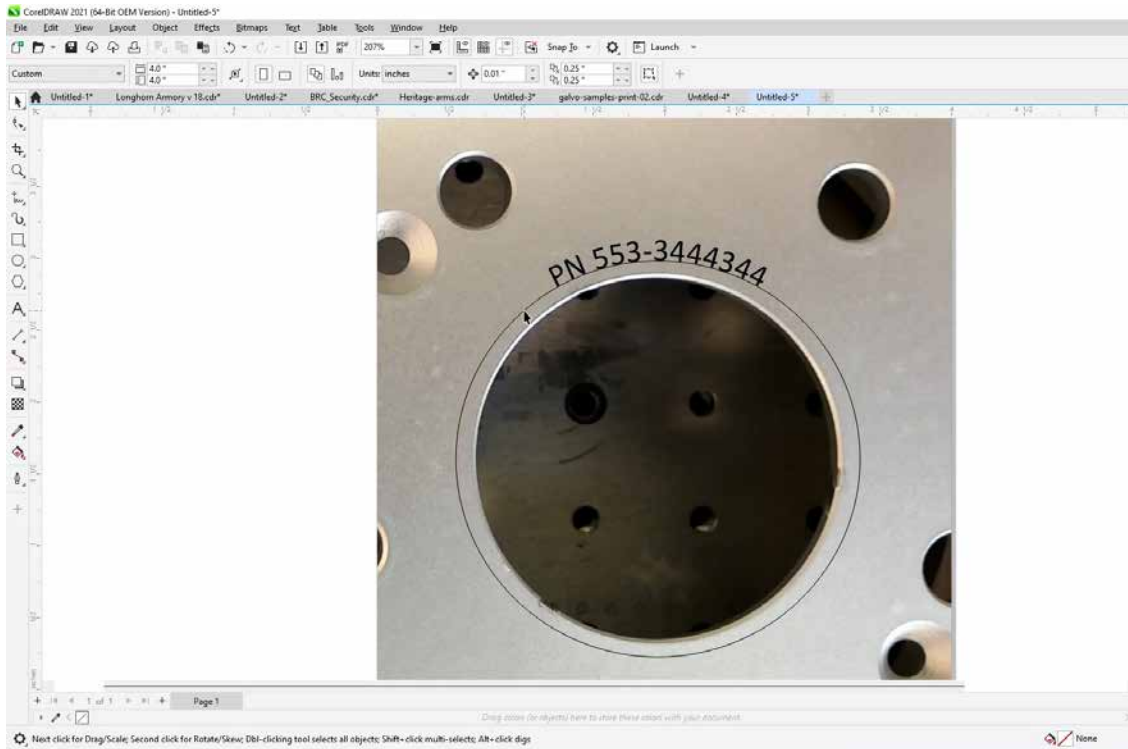

SECTION 5: THE LASER DASHBOARD

- The text box will appear and anything typed out will automatically follow the path of the line. Adjust your font face and size as needed.



- Once your text is ready, select the circle you used to curve the text with the Shape tool .
- Then click on the Pick tool  and hit **"Delete"** on your keyboard to remove the shape.
- Select the text, go to **File > Print** and change the Print Range to **"Selection"**, then print to the Epilog Engraver.

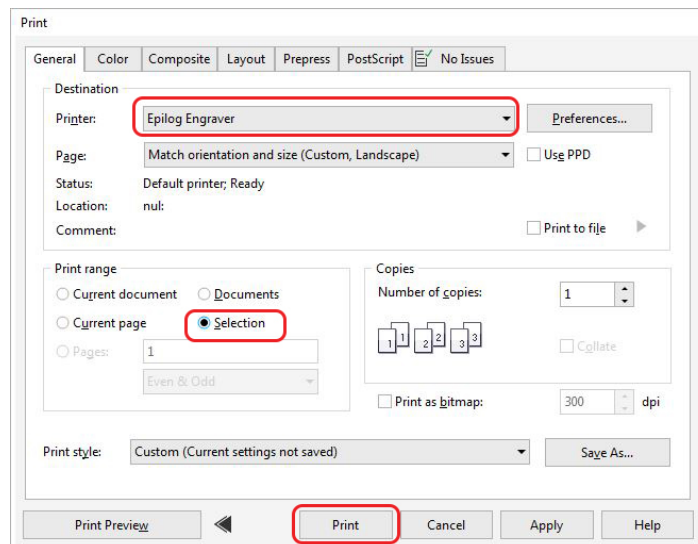

SECTION 5: THE LASER DASHBOARD

11. The text should now fit the shape of your engraving piece and be ready to print with your preferred settings.



Saving Your Settings

You have two ways you can save settings for your jobs - by material and by job.

1. **Settings by Material:** Next to each process you will see a small upload and download folder icon. These settings will only affect the currently selected process.
 - **Import** current material settings by clicking the folder with the down arrow. Select between the Engrave and Vector tabs, then choose your material from the list.
 - **Export** your new material settings by clicking the folder with the up arrow. Add a settings name and add it to an existing folder.
 - For step by step instructions see [w](#).

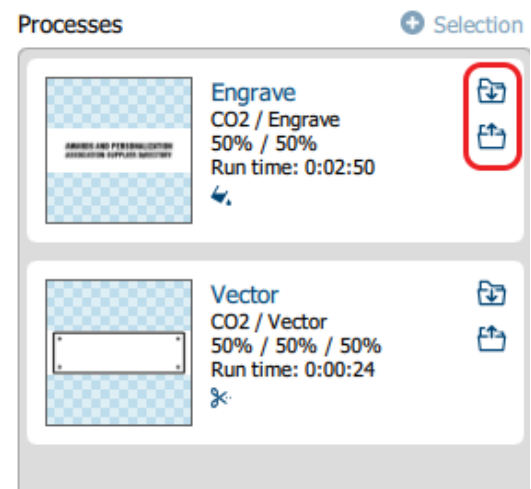

SECTION 5: THE LASER DASHBOARD

2. **Settings by Job:** Your settings for the entire job can be saved by clicking on the folder icons at the bottom of the Dashboard.

- Click the folder with the down arrow to import saved job settings.
- Click the folder with the up arrow to export your current job settings.



- When is this helpful? When you have a series of processes you use frequently. For example, you often use a specific two-ply plastic for creating signs. You can save both your engraving and vector processes.

File Settings

At the top of the Dashboard, you will see several file-related settings:

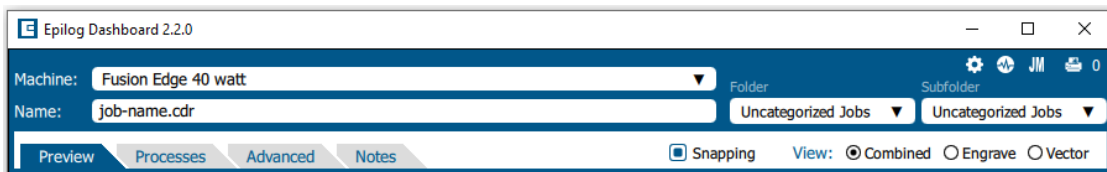

- **Machine:** Choose which laser you are sending the file to. This will show any lasers you have installed in the Job Manager.
- **Name:** Set your file name.
- **Folder / Subfolder:** Which folder and subfolder you want to save the file to in the Job Manager.
- **View:** This will change what portions of the graphic are shown in the preview. Choose to show all processes (Combined), or just your Engrave or Vector processes. This is a good way to preview your job and make sure you have set all of the lines you want to cut rather than engrave.

At the bottom of the page you'll see several additional file settings:



- **Time:** Displays the run time as the job is progressing.
- **Created / Printed:** Displays the date and time the file was created and last printed.
- **Print:** Press the print button to send the job to the laser.
- **Send to JM:** Press this button to send the job to the Job Manager.
- **Discard:** Delete the file from the Dashboard.

SECTION 5: THE LASER DASHBOARD

Settings in Detail

Resolution

Set your print resolution anywhere from 75 to 1200 DPI. For the best engraving results, use a resolution equal to the resolution in the raster images within your project setup. We recommend using a resolution of 400-500 for most standard engraving jobs. Use 600 DPI for jobs requiring finer detail. The resolution setting in the print driver will affect the engraving time (there are twice as many engraved lines at 600 DPI as at 300 DPI) and the quality. For a detailed discussion on Resolution, **visit “Resolution” on page 100.**

Engrave Direction

This feature applies to engraving only and allows you to engrave your project either from the top-down or the bottom-up direction. In standard top-down engraving there can be a large amount of engraving debris generated, especially on materials such as plastic, wood and rubber. As the debris moves toward the exhaust plenum, some of it collects in the area that has just been engraved. Bottom-up engraving prevents the debris from collecting in the freshly engraved spaces.

Process Type

Choose between the four modes of operation.

- **Off:** This setting will tell the laser to ignore any items within this process.
- **Hatch:** Used for most processes including text and graphics.
- **Engrave:** Used for engraving or marking materials.
- **Vector:** Selected when you are running only vector lines or for use with the Red Dot Pointer for previewing the job processing area.

Speed

Determines the travel speed of the carriage and is adjustable in 1% increments from 1 to 100%. The slower the speed, the deeper the engraving or cutting. Speed settings are heavily dependent on the hardness and the thickness of the material being engraved or cut, with harder materials requiring slower speeds for deeper engraving/cutting. **Please refer to “APPENDIX B: MATERIAL SETTINGS” on page 137 in this manual.**

Power

Determines the amount of laser energy that is delivered to the piece being cut and is adjustable in increments from 1 to 100%. The higher the power, the deeper the engraving/cutting. **Please refer to “APPENDIX B: MATERIAL SETTINGS” on page 137 in the manual.**

SECTION 5: THE LASER DASHBOARD

Frequency

The frequency setting is only active on vector processes, and controls the number of laser pulses that the laser fires per inch of travel. The frequency is set in the dashboard and can be adjusted from 1 to 100%. A lower frequency number will have the effect of less heat because fewer pulses are being used to cut the material.

Dithering

Dithering is used only for engraving processes and has no effect on hatch or vector processes. This setting defines how the dot patterns will be engraved in raster images that contain grayscale images, blends, or color. The Dashboard offers six different dithering patterns to enhance your engraving projects. The default mode is Standard. This mode can be used for all images including photographs, but some images improve when engraved with other dithering patterns.

Offset

Offset allows you to focus at any point above or below the surface of your material. When engraving acrylic, many users like to focus above the surface to produce a “softer” finish to the engraving. Conversely, when cutting acrylic, many users like to focus about halfway into the acrylic. Offset allows you to do this automatically. A positive value will move the table away from the focus lens. A negative value, such as $-.095$, will move the table closer the focus lens.

Guidelines

Guidelines are a new feature to help fine-tune your artwork placement while using the live camera view on the Dashboard. The guideline tool can be found on the left toolbar beneath the “Edit” and “Pan” buttons. Once the guideline tool has been selected, click and drag across the screen with the mouse to create guidelines. When a guideline is currently selected it will be red, if deselected it will be green. Hold down the “Ctrl” key to draw horizontal or vertical guidelines.

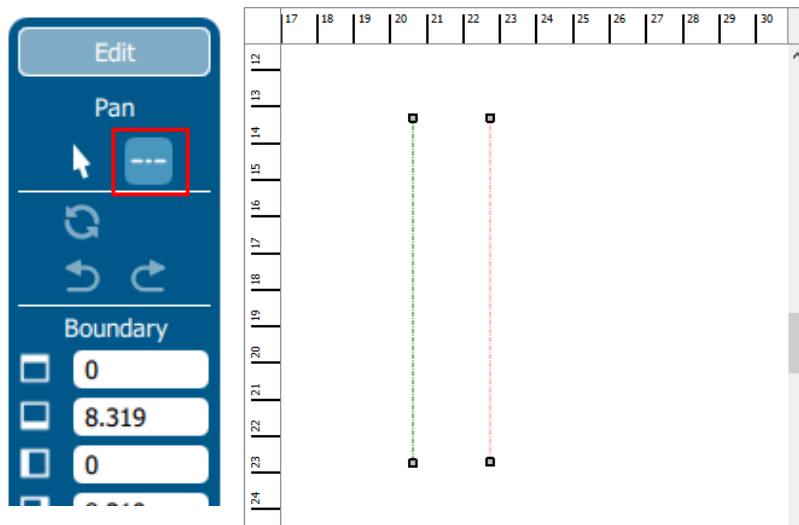

SECTION 5: THE LASER DASHBOARD

Creating and Modifying Guidelines

Once a guideline has been created, it can be modified by clicking and dragging an end point. This will move that end point while keeping the other end point in the same place. Alternatively, click and drag anywhere else along the guideline to move the entire line. Deleting a guideline is as simple as selecting the guideline and pressing the Delete key.

Snapping Guidelines

The end-points of guidelines will by default “snap” to other end points, the midpoint of a guideline, or anywhere that two guidelines intersect.

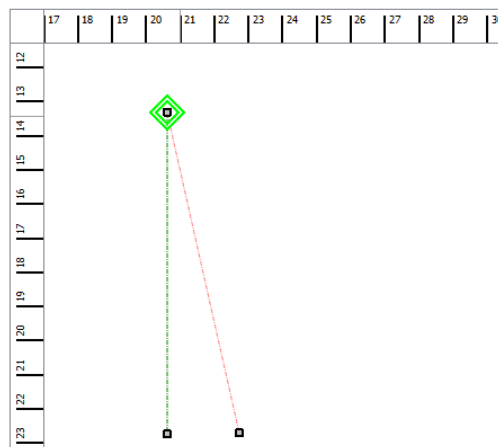

The Alt Key

The first end point of a new guideline will not snap to an existing guideline, because clicking near an existing line will move or manipulate the existing guideline. To get around this, hold down the “Alt” key while creating the new guideline. Holding down the “Alt” key will disable moving an existing guideline and will allow the first end point of a new guideline to snap to an existing line.

By holding down the “Alt” key while highlighting a previously drawn line, you will see a green square appear where you want to start your new line. The green square indicates you are connecting lines together.

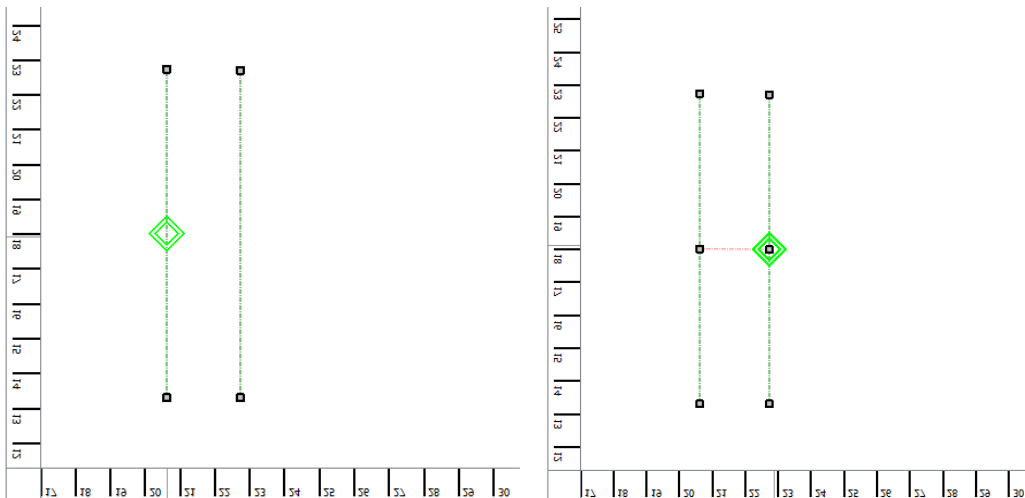

SECTION 5: THE LASER DASHBOARD

Snapping can be turned off by unchecking the “Snapping” checkbox just above the job preview area.

Snapping Artwork to Guidelines

Artwork can also snap to guidelines. Once you have created your guidelines, switch back to the default selection tool. Select your artwork and move it near a guideline. The corners, midpoints, and center of the artwork will snap to points along the guidelines.

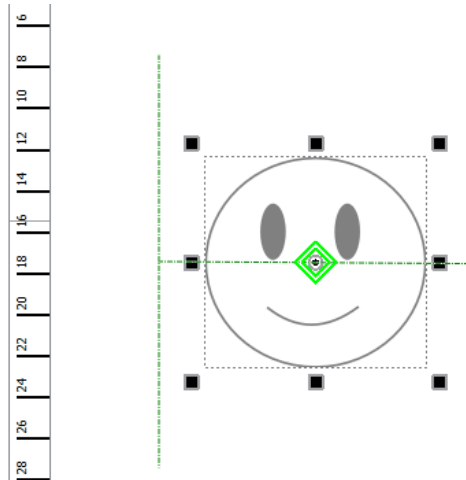

Artwork will also snap to guidelines while rotating.

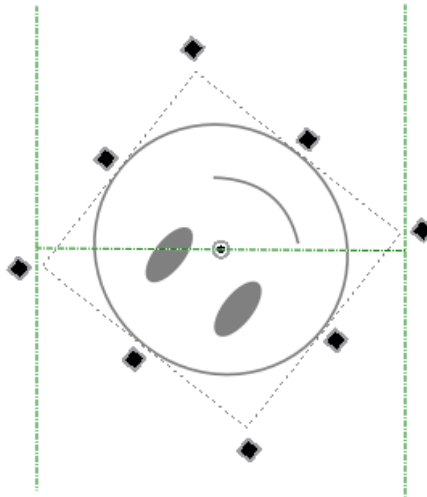

SECTION 5: THE LASER DASHBOARD

Guideline Tips

Moving and aligning objects to the center point of your material:

1. Draw two guidelines along the vertical or horizontal Galvos of your material.
2. Draw a guideline connecting the midpoints of the two lines. Remember to hold "Alt" to get the starting point of the guideline to snap.
3. Move the artwork so that the center of the artwork selection snaps to the midpoint of the last guideline you drew.
4. Rotate the artwork until it snaps to the guideline.



Processes Tab

The Processes tab is an alternative view of the various processes within your file. You can see each process with the settings located next to the process without the video view of the table.

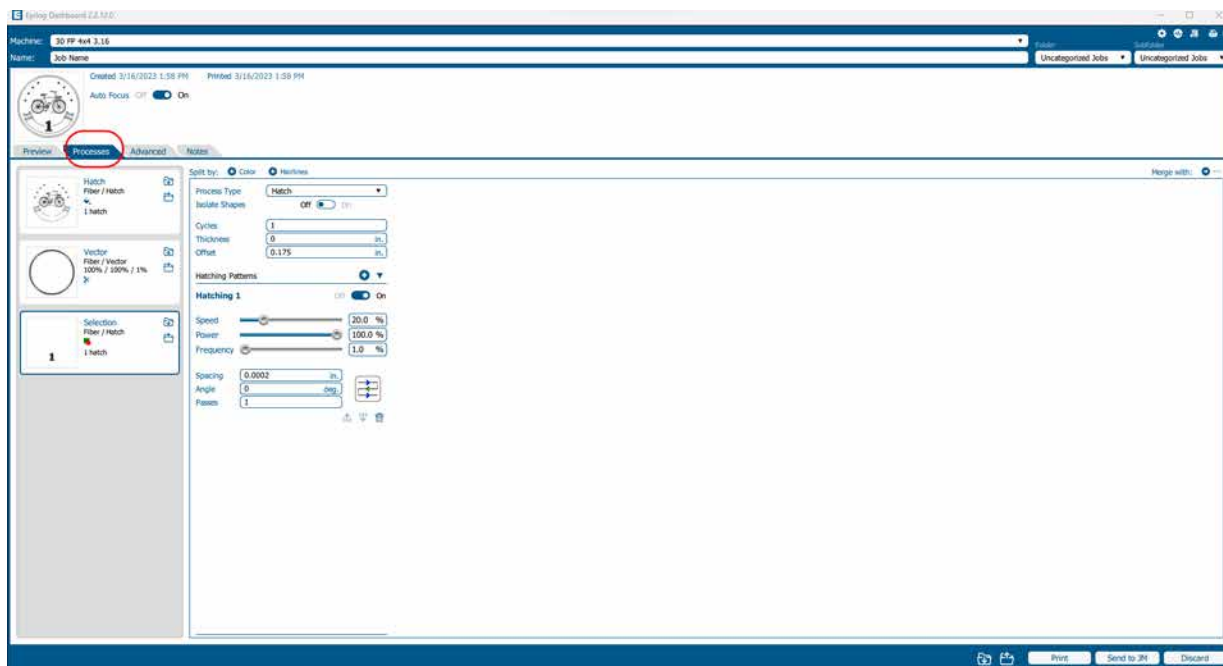

SECTION 5: THE LASER DASHBOARD

Advanced Tab

On the Advanced tab, you can change settings that will affect the entire job.

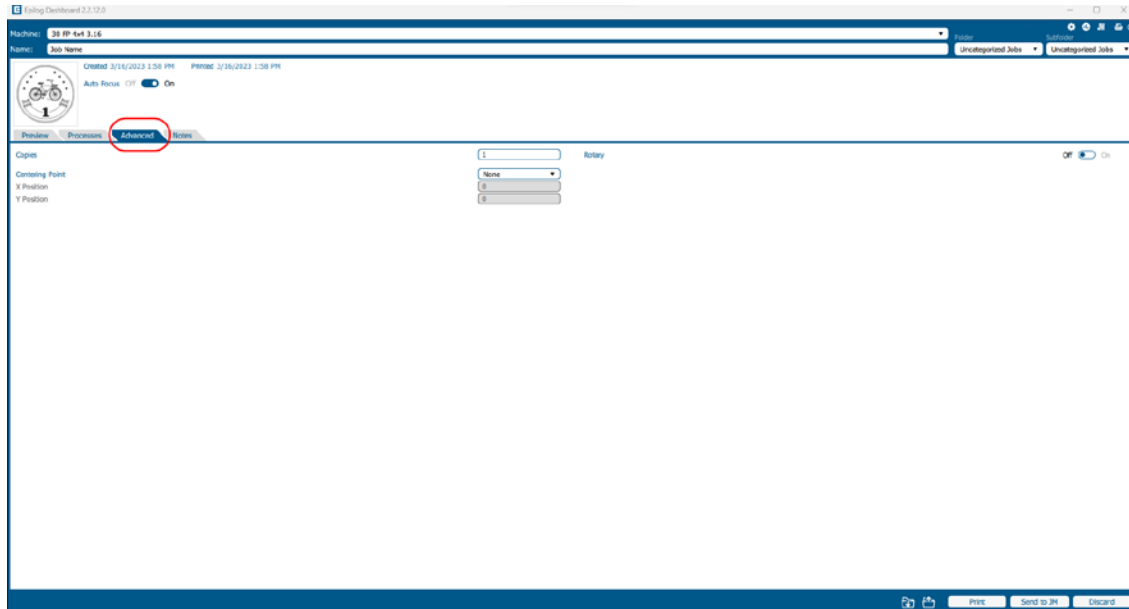

- **Copies:** Set the number of times you would like to rerun the job. If you have 2 processes, the laser will complete each of the two processes, then run the two processes a second time. If you have a process with more than one cycle (process 1: cycles 1, process 2: cycles: 2) and set the copies to 2, it will run process 1 once, process 2 twice, then process 1 once again, and process 2 twice more.
- **Centering Point:** This feature is used in conjunction with the Jog feature at the control panel.

Notes Tab

Use the Notes tab to keep notes on running your file. This can include suggestions for artwork placement, speed and power notes, or anything else a laser operator may find helpful when running that project.

SECTION 5: THE LASER DASHBOARD

Additional CorelDRAW Laser Dashboard Features

Each program you use will provide different ways to manage these functions. CorelDRAW offers a very straight forward way to access each of these features.

Multiple Passes

You can automatically engrave or cut a job multiple times by setting the Number of Copies to the number of passes that you want to make. When each pass is finished the laser will automatically start another pass until all passes are complete.

Print Range

If you only want to print one aspect of your project (for example, just the text in the document), you can select that part of the file, then when you select your print settings click **Selection** and the laser will only engrave or cut that piece of your file.

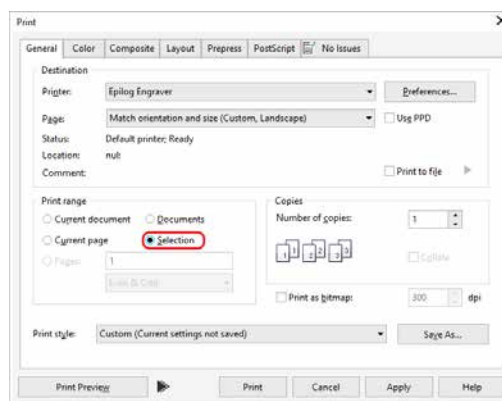

Multiple Pages

When you want to engrave multiple pieces within one document, each with a different name, you can use the Multiple Pages feature of CorelDRAW. Set up each of the coaster files on a separate page in your single CorelDRAW file, then when you print to the laser you can choose either **Current document** to print all of the pages or you can specify which pages you want to print by adjusting the settings in the **Print range box**. You can view the different pages in the Print Preview screen.

When a multiple page job is printed to the laser, each of the pages will transfer to the Control Panel with the first file coming across as Job:1. File Name, then Job:2. Page 2, Job: 3. Page 3. Remember, the last page of the job will be the current file when you go to the Fusion's control panel, so scroll back to Job 1: File Name to run that one first.

If you start engraving the jobs and become uncertain about which pages are which, you can refer back to your print preview screen and the Page number in the laser will correspond to the page number in the print preview.

SECTION 6: CONTROL PANEL

Display

The display shows valuable information associated with the highlighted Functional Menu items. We will explain the different information that will be displayed as we go through the description of each menu item.



Reset



Power



Door Open/Close



Speed



Focus Menu



Job Menu



Pointer



Delete



Jog Menu



Settings Menu



Trace



Status Indicator

In the bottom left corner of the screen you will see text displaying the current status of the machine.

- **Homing:** This indicates the machine is still powering on. None of the functions are available until powering on is completed.
- **Idle:** The machine is inactive and ready to run or resume a job.
- **Running:** A job is in progress when this is displayed.
- **Parking:** The axis is returning to Home position.
- **Jogging:** Jog mode is active.

Symbols



Go/Stop Button

Press the Go/Stop button to start and pause a job.

SECTION 6: CONTROL PANEL

- Pressing the Go/Stop button during a running job will stop the lens carriage and the laser beam will be shut off. If the Go/Stop button is pressed during raster engraving mode, the lens carriage will pause on either the far left or far right of the engraving line that is in process. If the Go/Stop button is pressed while in vector cutting mode, the lens carriage will stop at the end of a line segment or at the next line node location.
- Once the lens carriage has stopped, you can open the door to examine the job. By closing the door and pressing the Go/Stop button, the job will commence where it left off. If the item being engraved/cut has not been moved, the engraving/cutting registration will not be affected.
-  **Note:** Opening the door on the laser during engraving or cutting will stop the laser from firing; however, the lens carriage will continue to move. It is important to stop the job before you open the door to ensure the engraving/cutting is completed.
- If you press the Go/Stop button while in vector mode it may take some time for the system to actually stop. The system needs to get to the next node in a vector before it can stop.

LED Status

The ring around the Go/Stop button will change certain colors depending on the Fusion Galvo's status.

- **White:** The machine is booting.
- **Purple:** The machine is waiting for the touch screen configuration to load.
- **Multi-colored:** The machine is Homing.
- **Alternating Light Blue to Green:** Machine is Idle and ready to run a job.
- **Green:** Machine is actively running or tracing a job.
- **Red:** A drive has failed. The number of flashes determines the drive number that failed. If more than one drive has failed, it flashes for the first sequential drive.
 - 1 - X Axis
 - 2 - Y Left Axis
 - 3 - Y Right Axis

Reset Key

- Pressing the Reset key will move the carriage back to its Home Position. Press the Reset key after you have moved the carriage when in Jog mode.
- You may also press this key if you want to start a job over after pausing it with the Go/Stop button. Reset does not erase the job from the laser systems memory; rather it will stop the engraving job in process and send the carriage back to the Home Position.



Focus

The Focus function allows you to manually set the table to the correct height for engraving while using the Focus Gauge. With Focus highlighted, use the Joystick to move the table up or down. The display will show a digital readout of the table position. Press once to enable the Focus feature and the icon will turn green. Press again to exit this feature.

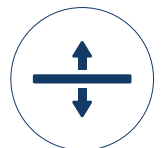

SECTION 6: CONTROL PANEL

Pointer

The Pointer key is a toggle switch that turns the laser system's Red Dot Pointer on and off. **For more information visit "Red Dot Pointer" on page 116.**



Jog

The Jog function allows you to move the laser beam around the table with the use of the Joystick. To make it easier to use, turn on the Red Dot Pointer for a visual indicator of where the carriage is moving. The carriage can be moved in X, Y or diagonally. The display will show a digital readout of the carriage position. This function is useful for bringing the focus gauge to any object on the table to ensure it's focused properly.



Trace

The Trace function allows you to preview the placement of your artwork on your work piece before you run the job. To use, turn on the Red Dot Pointer, select your job from the Job Menu, and press the Trace key. The laser head will begin tracing the entire outline of your job repeatedly. To stop tracing, press the Trace key again.



Job Menu

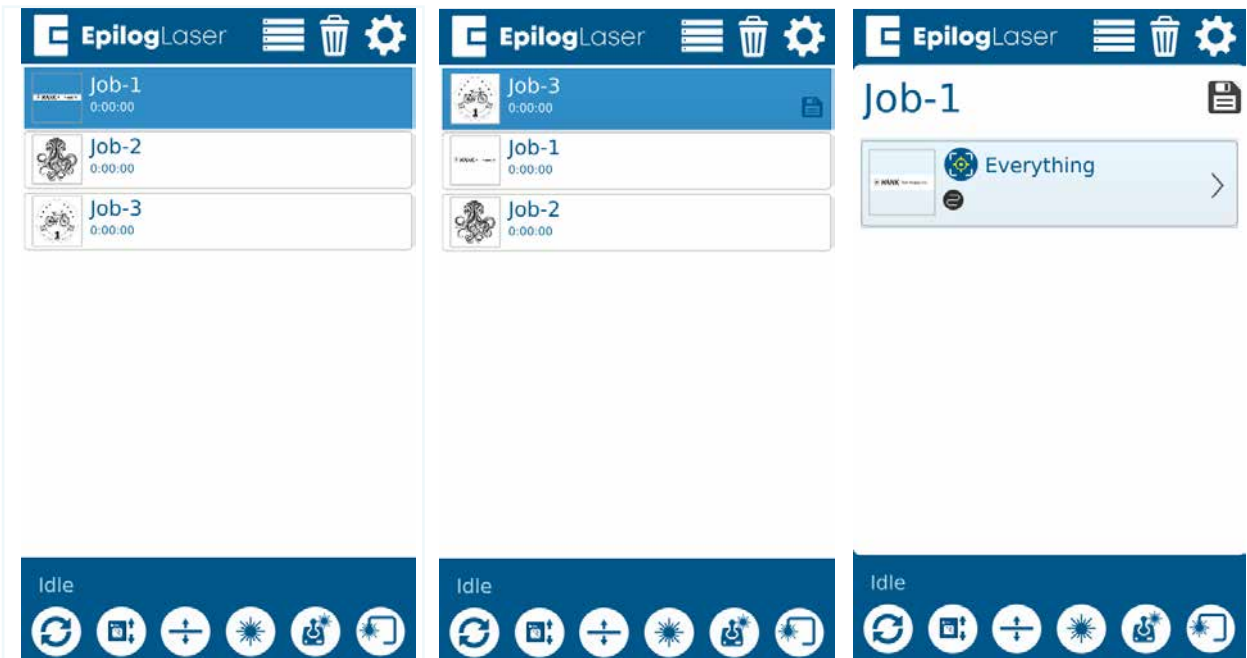

- The Job Menu allows you to scroll through the jobs in your laser system. You will be able to see a list of jobs that have been sent to the laser. The job name displayed is the same as the file name that you printed to the laser.
- When the job you want has been selected, it will be highlighted in blue. Press the Go/Stop button to start the job.

SECTION 6: CONTROL PANEL

- After the job starts, the job's settings and a timer will be activated and will be shown at the bottom of the display.
- Saved jobs will always be visible at the bottom of the list with a save icon next to the job name.



Pressing and holding down your finger on a job will pull up the job's settings, allowing you to view the Speed, Power, and Resolution or Frequency. A save button will also be visible in the upper right corner that allows you to save the job permanently to the laser.



Speed

This icon indicates the speed settings on the selected job. It ranges from 1-100%.



Power

This icon indicates the power settings on the selected job. It ranges from 1-100%.



DPI

This icon indicates the resolution settings on the selected job. It ranges from 75-1200.



Frequency

This icon indicates the frequency settings on the selected job. It ranges from 1-100%.

SECTION 6: CONTROL PANEL

Delete Button

The Delete Button will permanently erase jobs from the Job Menu. To delete a job, select the job in the Job Menu, and then select the Delete Button. A dialog will pop up to confirm that you want to delete the file. Select “Yes” and the file will be removed from the Job Menu.



Note: If you have marked a job as “Saved” and delete the file, it will still be erased from the Job Menu.



Settings/Config Menu

The Settings/Config menu has three sub-menus, System, Network, and About Machine.

System

Once selected, the System Settings display detailed information about the machine. These are factory settings that should not be changed unless instructed by Epilog Technical Support.

Network

Once selected, the Network Settings allow you to change the IP Address and the Netmask. The IP Address on this screen should match the IP Address you have assigned your machine in the Job Manager. If you have multiple machines, each one will need its own IP Address. For more information, see “**6. Set the Fusion Galvo’s IP Address**” on page 22.

About Machine

Once selected, this section displays info about your laser’s firmware version, laser power, and Serial Number.

Park Axis

Pressing Park Axis returns the Laser to the Home Position.

Home Axis

Pressing Home Axis repeats the Homing process that happens when the machine powers on.

Home Table

Home Table resets the table height to its Home Position.

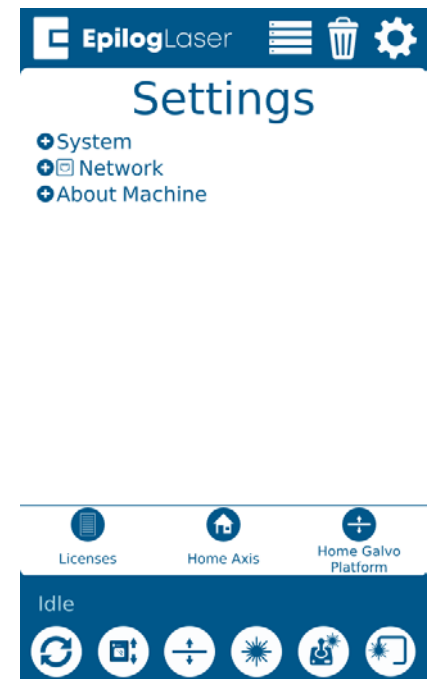

SECTION 6: CONTROL PANEL

Advanced Settings

Access the Advanced Settings Menu by first going to the Settings Menu, then long pressing the text “Settings” at the top of the screen.

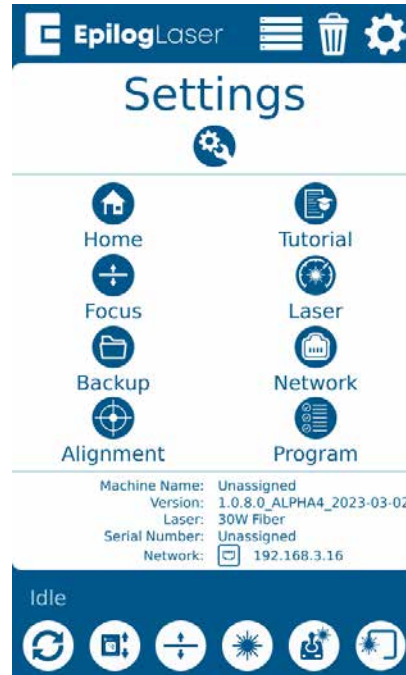

In this menu you have options for calibrating various parts of the machine, including the Joystick, Cameras and Auto Focus. Each option provides step by step instructions for each process.

For more information about Camera Calibration, **see “Camera Calibration” on page 149.**

For more information about Auto Focus Calibration, **see “Calibrating the Auto Focus” on page 147.**

SECTION 6: CONTROL PANEL

Jog Menu



Access the Jog Menu by pressing the Jog key, which will turn green when active. The Jog Menu is used to control the Rotary Attachment on the Fusion Galvo G100.

Locking Coordinates

The X and Y coordinates may be locked and unlocked to help you fine-tune the laser beam's position. Tap the lock icons to lock or unlock the X and Y coordinates. When only the X coordinate is locked, the joystick will only move the laser beam in the Y direction (toward the front or back of the machine). When only the Y coordinate is locked, the joystick will only move the laser beam in the X direction (left or right). If both the X and Y coordinates are locked, the laser head will not move until they are unlocked.

Move To

Enter X and Y coordinates to move the laser to a specific location on the table.

Centering Point

Pressing this button tells the laser where you want the center of your artwork to be. While jogging the laser beam across the table, use the red dot pointer to help identify the center point of your engraving. The Centering Point feature is used with Center-Engraving enabled jobs.

Park Axis

Park Axis returns the laser beam to the default home position.

Nudge

The Nudge arrows allow you to fine-tune the position of the laser down to a thousandth of an inch. To change the increments you want to nudge the laser's position, click the text box under "Nudge" and enter an amount.

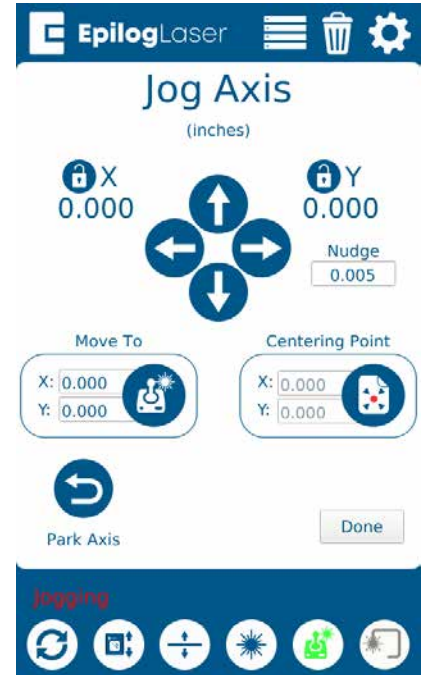

SECTION 6: CONTROL PANEL

Focus Menu



To access the Focus Menu press the Focus key, which turns green when active. The Focus Menu is used for raising or lowering the table level to focus the laser precisely to your engraving or cutting material using the Focus Gauge. The height of the table is adjustable by either using the joystick, or using the Nudge arrows. Once you are finished using the Focus Menu, press the Focus key again to return to the main Job menu.

Move To

Enter an amount to focus the table to the laser at a specific height.

Nudge

The nudge arrows allow you to fine-tune the position of the laser down to a thousandth of an inch. To change the increments you want to nudge the laser's position, click the text box under "Nudge" and enter an amount.

Settings

Pressing the gear icon on the Focus menu allows you to save "Thickness Presets" which can be useful for items you work with regularly that have a consistent thickness. Simply type in the table height you wish to use and save the presets by pressing the save icon. Now when you press the numbers 1, 2, or 3 on the focus menu, and then press "Move To", your machine will adjust the table to that height.

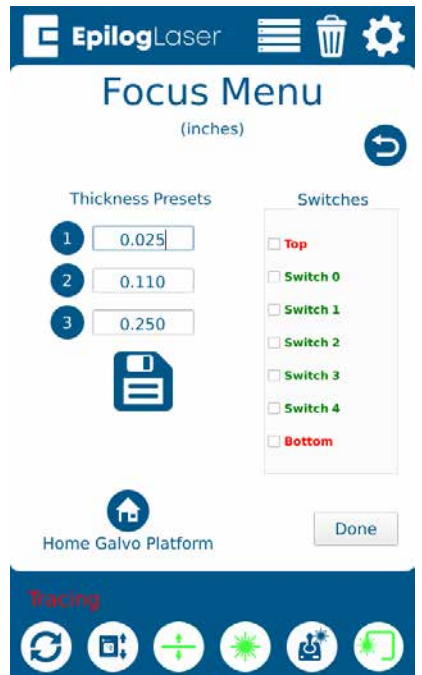
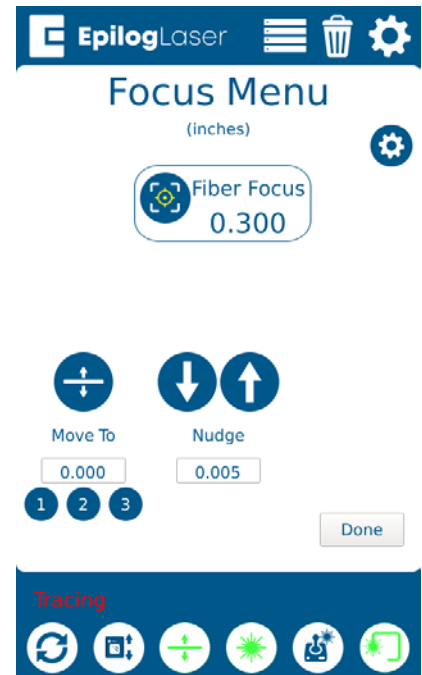

SECTION 6: CONTROL PANEL

Joystick

The Joystick feature is used in Jog mode and Focus mode. The Joystick is progressive and touch sensitive and provides a continuously variable range of adjustments. It is sensitive to the degree of tilt that is being applied. The more you tilt the Joystick, the bigger your impact on the function you are using.

Job Storage

The Fusion Galvo has 1 GB of permanent storage. While powered on, the machine will store any and all jobs sent until there is no free memory left. This feature allows you to save your most run jobs right at the laser without needing to first print them from the computer.

To save a job, press and hold down on a job in the Job Menu until it pulls up the job's settings. Select the save button in the upper right corner and the job will save permanently to the laser until manually deleted. If you do not save a job, it will be deleted upon powering down the machine.

SECTION 7: QUICK START GUIDE

Artwork Setup

Create your job in the graphics software of your choice, such as CorelDraw or Adobe Illustrator. There are three different modes of operation for the laser and the way you setup your artwork will determine if you use Hatch, Engrave, or Vector.

Hatch

Hatch mode is the most commonly used setting and allows the laser beam to engrave or mark at any angle to normal. For instance, if you want to perform a deep engraving function, you might incorporate hatching angles of 0, 45, 90, and 135 degrees. In this case, the different Hatch angles produce a more consistent background.

Engrave

Engrave mode can best be described as very high-resolution dot matrix “printing” with a laser. Engrave is used to create highly detailed graphic images. You can engrave scanned images, text, clipart, photographs, or line drawings.

Vector

When you are vector marking, the laser is following a continuous path that follows the outline or profile of an image.

Setting a Vector Marking Line

With the new Job Manager you no longer have to set a line width to “Hairline” to ensure that it will print to the Dashboard as a Vector process. This allows you to have many options for setting your Vector Cutting lines. The easiest way to do it is by **line width**, but you may also set it to Vector by a specific **color** or by selecting the individual processes in the Dashboard that you want to cut instead of engrave. The key is to be consistent in which method you pick to avoid confusion. For more information, **see “Presetting Your Vector Lines” on page 71.**

SECTION 7: QUICK START GUIDE

Where do I set the Vector Line Width?

Different software packages set the line width in different places. In CorelDRAW, you can find the outline width in the top menu bar when a vector line is selected. In Adobe Illustrator it is called the stroke width and you can find this setting in the Stroke Panel. Vector line width will vary from program to program.

If you can't select a line to set the width, it may be because it is part of a grouped object. Try to ungroup the object, then select the line. You also can't select an individual line if that line is part of a raster image.

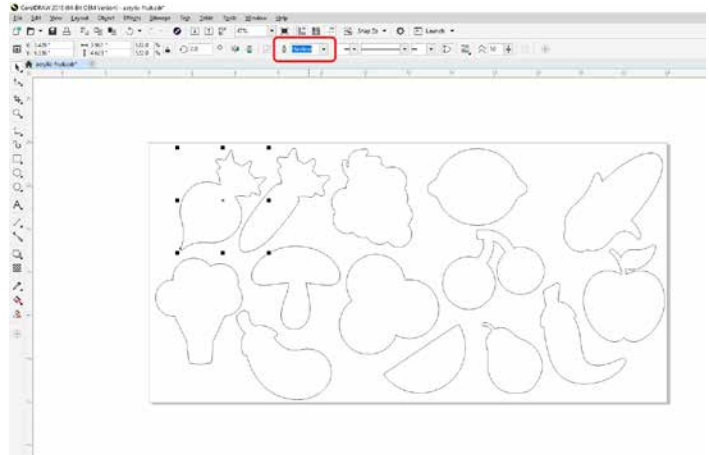

Resolution

Resolution is for use with engraving processes in the Laser Dashboard. Print quality is commonly referred to as Resolution and is one of the variables that determine image quality. Resolution is expressed in dots per inch (DPI) and is determined by the number of lines or dots that are engraved for every inch of movement. Each horizontal line is referred to as a raster line. The higher the resolution setting, the finer the detail that can be achieved. Keep in mind that engraving resolution is only one factor in determining image quality. The quality of the artwork being sent to the laser can have a bigger influence on the look of the final product than the resolution. If low quality artwork is being used, even the highest resolution will not improve it. Also keep in mind that image quality is subjective. 300 DPI may be just fine for some images and some customers, while 600 DPI is the absolute minimum for others.

This diagram shows the concept of raster lines and dots-per-inch (DPI). The arrows show the change in direction of the carriage between raster lines. The difference in dot density between 300 DPI and 600 DPI.

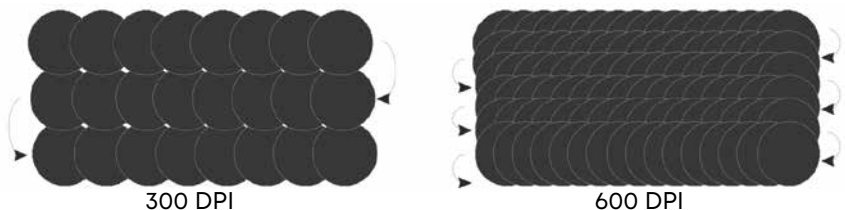

SECTION 7: QUICK START GUIDE

Engraving Resolution Settings:

75 – 300 DPI

These resolution values are typically used for non-production purposes where you want to experiment with image location, or if you want to quickly produce a rough draft. Low resolution settings are also useful when engraving products that you don't want to remove too much material from while engraving, such as fabric.

300 DPI

300 DPI is useful when engraving materials such as glass, marble, plastic and other items that don't benefit from the engraved dots being close together.

500 DPI

This is the default setting for resolution in the Software Suite. This resolution value is ideal for many applications. It combines very good image quality with fast engraving times. Many users like 500 DPI for all of their work.

600 DPI

When really fine detail or overall excellent results are required, most users choose 600 DPI.

1200 DPI

This resolution is used for projects that require the best engraving quality possible, or if engraving extremely small fonts. Although it's seldom used because, under normal circumstances, most people cannot visually discern the difference between 1200 and 600 DPI. There are some users that appreciate this high level of quality and are willing to take twice as long to produce an image at 1200 DPI as it would take them at 600 DPI.

Helpful Hints

- There are four times as many dots engraved at 600 DPI as there are at 300 DPI. Twice as many horizontally and twice as many vertically.
- The gap between the dots is very small at 600 DPI. At 300 DPI the lesser overlap is responsible for the jagged edges that are visible when engraving at lower resolutions.
- It's important to remember that while resolution plays a part in producing good image quality, the artwork that is sent to be engraved is just as important. If the artwork that is sent to the laser is poor quality, trying to engrave it at 600 DPI will not improve the quality. It's always best to start with high resolution images. Poor artwork will probably always look poor at any resolution, while good artwork will look good at any resolution.
- Twice as many dots and twice as many lines at 600 DPI produces a much deeper burn into materials like wood than you would see engraving the same image at 300 DPI. This is important to understand because depth of burn is closely associated with engraving resolution – the higher the resolution, the greater the depth of burn for a given speed. The relationship between resolution, depth of engraving and Speed and Power setting is something that most people figure out with just a little experience. **“APPENDIX B: MATERIAL SETTINGS” on page 137** helps to make this easy to understand by providing different Speed and Power settings and suggested engraving resolutions for each different material listed.

SECTION 8: SYSTEM FEATURES

IRIS™ Camera Positioning System

The Fusion Galvo includes the IRIS™ Camera Positioning System which allows you to precisely place your artwork on screen in seconds. The overhead camera provides a live picture of the working area for accurate artwork placement.

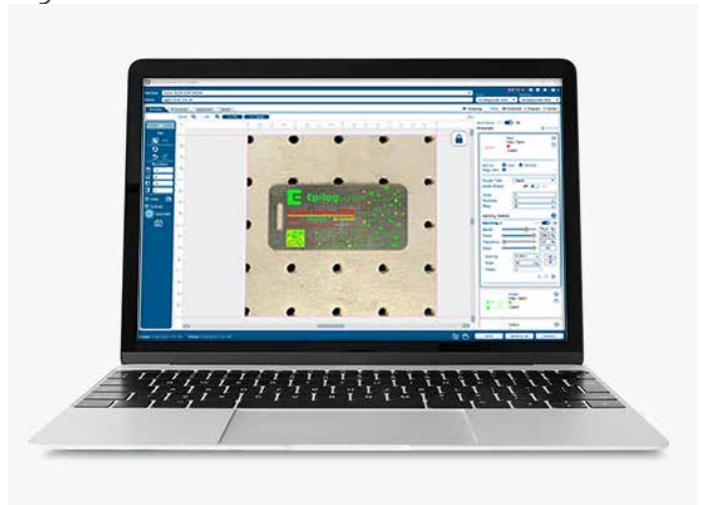

Using the IRIS™ Camera

The live preview of your projects can be viewed within the Epilog Dashboard under the Preview tab. The IRIS™ Camera Positioning System will provide the most accurate results when:

1. The piece being cut or engraved is placed **directly underneath the camera(s)**, and
2. The table level is **focused to the piece**. If the piece is not in focus on the table, the artwork may not be aligned properly in the live preview on the Dashboard.

The camera may also be calibrated for improved accuracy. **For more information, see “Camera Calibration” on page 149.**

Touch Screen

The laser of the Fusion Galvo is controlled by a 7” capacitive resolution touch screen. This feature allows you to select between jobs, change settings, and more. For more information on how to use the touch screen, see **“SECTION 6: CONTROL PANEL” on page 89.**



SECTION 8: SYSTEM FEATURES

Exhaust

The exhaust feature on the Fusion Galvo Laser is used to keep combustible gases away from the marking surface.

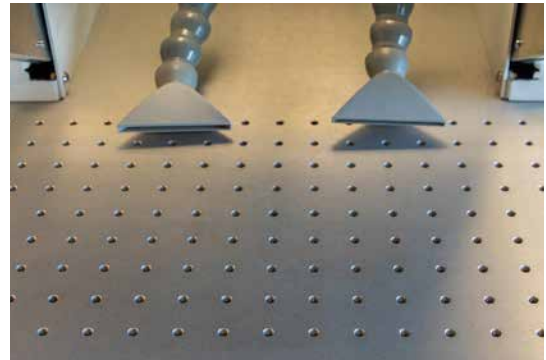

Auto Focus vs Manual Focus

In order to engrave or cut a crisp, clean image, your material must be the correct distance from the bottom of the focus lens. Setting the distance from the bottom of the focus lens to the top of your material is the process of focusing, and is accomplished by placing your material on the table and moving the table up or down.

Focusing Options:

1. At the machine, press the Focus Menu button on the control panel display to initiate red diode cross with Red Dot Pointer spot. Move the joystick up or down to raise or lower the Galvo platform until the Red Dot Pointer spot overlaps with the vertical line on the cross.
2. Place the manual focus gauge on the Galvo platform focus hanger. Press the Focus Menu button on the control panel display and raise / lower the galvo platform until the manual focus gauge touches the surface of the material to be marked / engraved. Once focused, remove the manual focus gauge.
3. Using a caliper, measure the thickness of the material to be marked / engraved. Press the Focus Menu button on the control panel display and use joystick to raise / lower galvo platform until the control panel focus location display matches the thickness of measured material.
4. In the Laser Dashboard, set Auto Focus to ON. Input the material thickness in the laser parameter settings to allow for the laser system galvo platform to automatically adjust to the correct focal plane, based on material thickness. **NOTE:** Using this method will affect the mark / engrave location relative to camera view. Using the TRACE function is recommended before running the job to ensure correct mark / engraving location.

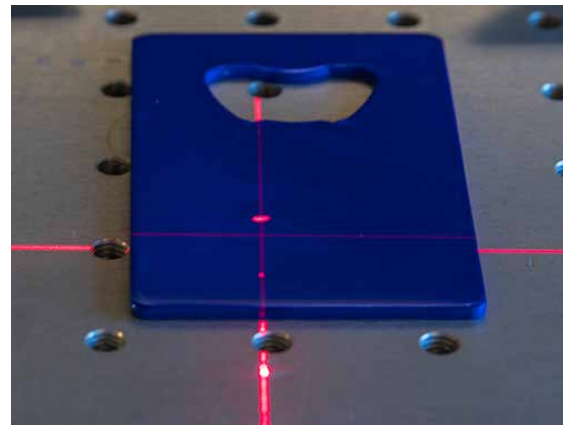

Auto Focus

Activating the Auto Focus can be done on your computer in the Auto Focus box in the Dashboard. The default setting is "Off", but you may measure your material's thickness and input it into the Dashboard.

Thickness Mode: If you select this mode, you must enter the thickness of your object in the Processes

SECTION 8: SYSTEM FEATURES

Section under each individual process. If all processes in your job need to be focused at the same level, it may save you time to enter the thickness before splitting the job into multiple processes. For more information on splitting processes see **“Dividing Your Job Into Processes” on page 73**. For more information about Thickness Mode, see **“Thickness” on page 69**.

Manual Focus

This photo shows the Fusion Galvo focusing system. Place the object on the table of the machine, then place the manual focus gauge on the hanger above the object. Select the **Focus Menu** button on the touch screen and move the **Joystick** up or down to move the focus gauge appropriately until your object just touches the bottom of the gauge. The speed at which the focus raises or lowers can be controlled by applying varying pressure upwards or downwards on the **Joystick**.

You may also fine-tune the focus in the Focus Menu. Once the focus position has been established, place the manual focus gauge back to its magnetic plate. Press the Focus Menu button again to leave the menu.

If your material has a taper or curve, pick an intermediate point between the highest and lowest points being engraved and focus on that point. In general, the area of the material being engraved needs to be relatively flat. If the area being engraved differs in height by more than about an .125” (3 mm), the image will begin to look “fuzzy” or out of focus.

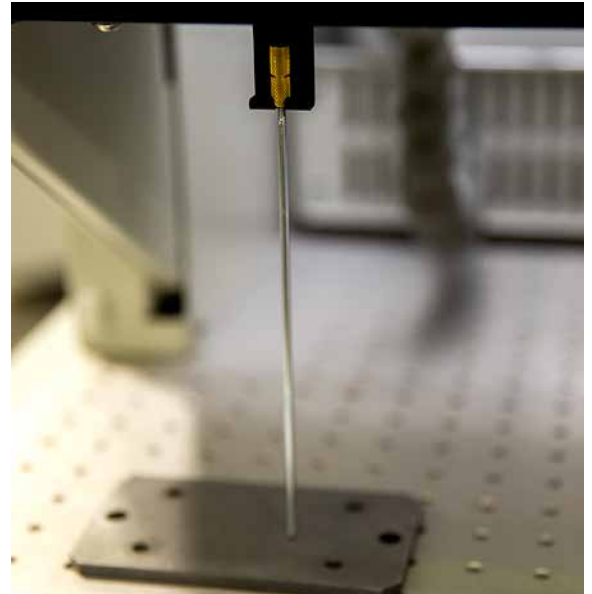

Red Dot Pointer

The Red Dot Pointer is a visible laser beam that traces the outline of your artwork.

Job Trace

By pressing the trace button you can trace your job at the laser to see an outline of where your project is going to engrave.

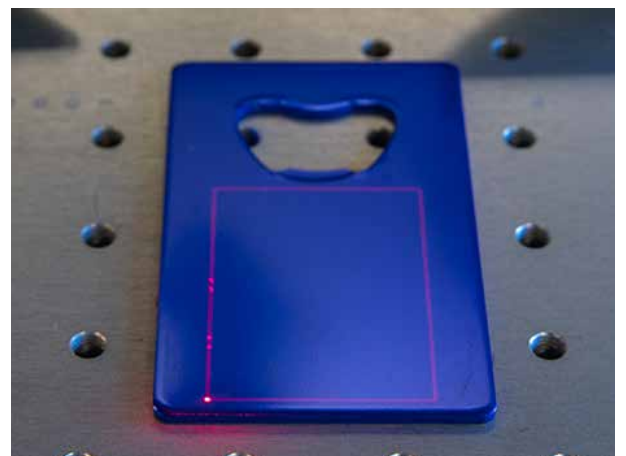

SECTION 8: SYSTEM FEATURES

Emergency Stop

Above the display panel, you will see a large, red Emergency Stop Button. If there is an emergency, such as a fire, immediately press the Emergency Stop Button. The laser will immediately stop and the system will shut down.

To reset the system on the Galvo G100, you must turn off the system using the Key Switch, then twist the Emergency Stop Button clockwise to release the system, then turn on the laser. If your laser ever stops running and you can't turn it on, check to see if the Emergency Stop Button has been pressed by accident.



Door Handles

The Fusion Galvo G100 includes handles on either side of the door, allowing you to open the door while the machine is powered down. This is useful for when you need to plug in and unplug the Rotary accessory while the machine is powered down. The magnetic latches on either side of the machine help hold the door up when manually opening the door.



SECTION 8: SYSTEM FEATURES

Calibration Mat

The Calibration Mat used for calibrating the camera is included with your machine and can be stored in the pocket located on the back of the machine. **For more information on calibration, see “APPENDIX C: SYSTEM MAINTENANCE” on page 147.**

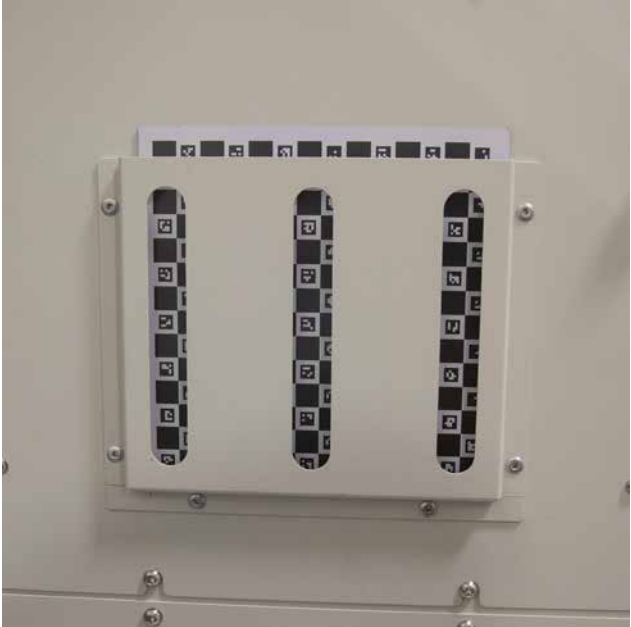
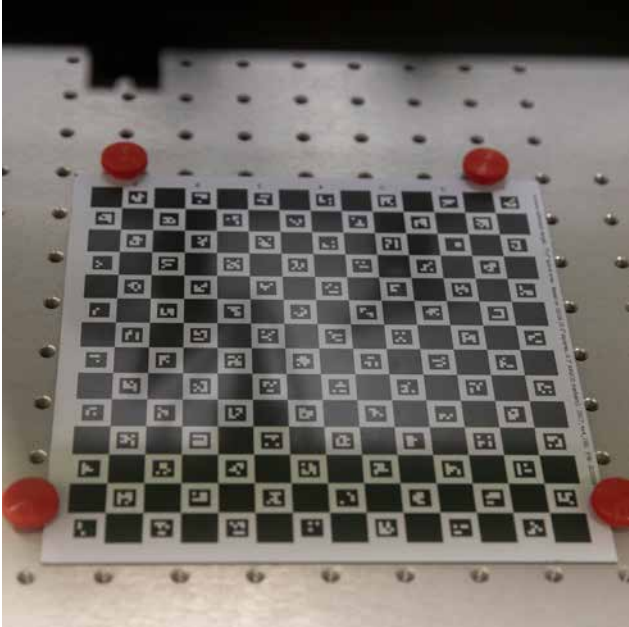

SECTION 9: OPTIONAL FEATURES

Fusion Galvo G100

Rotary Setup



STOP! Before using the Rotary for the first time, you will need to update your machine to the latest firmware. For more information see **“SECTION 10: UPGRADING FIRMWARE”** on page 121.



An important note: It's very important that the laser system is always turned off before installing (or removing) the Rotary Attachment. The Fusion Galvo G100 laser system will not recognize the Rotary Attachment until the system is rebooted, and you could damage the electronics if the rotary is installed while the laser system is powered on.

1. After updating the firmware on the Fusion Galvo G100, you will need to update your settings at the display. First press the **Settings Menu** key in the upper right corner.



2. In the Settings Menu, press the gear icon to navigate to the **Configuration Menu**.

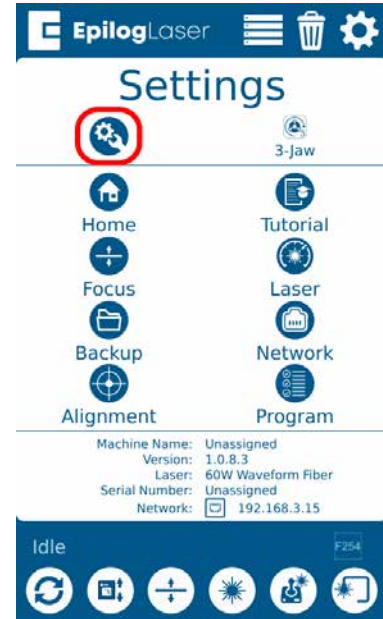

3. At the Configuration Menu, select **“Rotary”**.



SECTION 9: OPTIONAL FEATURES

4. Now Select **“Rotary Encoder”**.

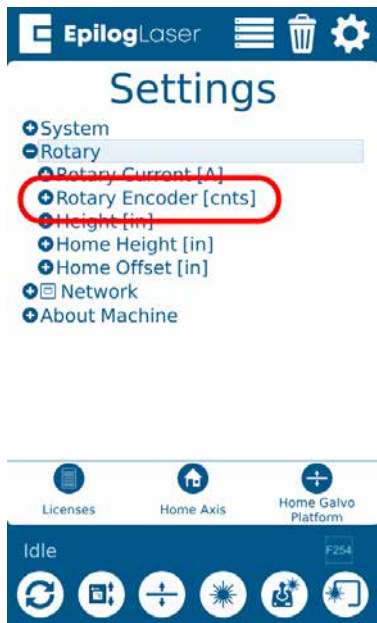

5. Select the number shown and change it to **“38425”**.

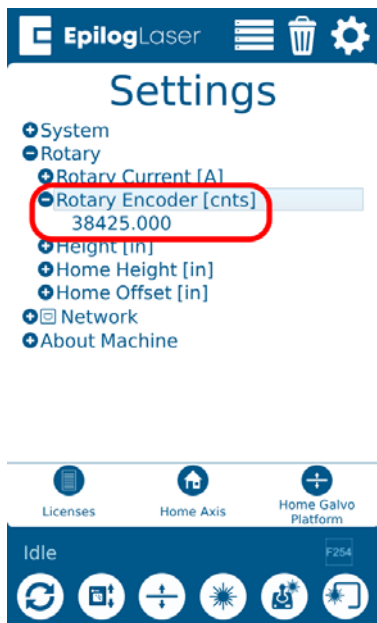

6. Once the number has been updated, press **“OK”**.

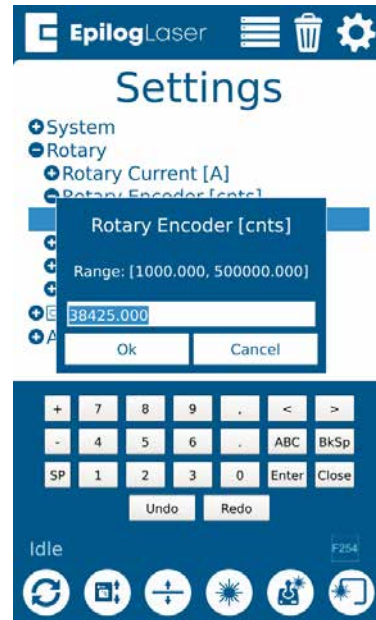

7. You are now ready to start using your 3-Jaw Chuck Rotary attachment with the Galvo G100.

SECTION 9: OPTIONAL FEATURES

Fusion Galvo 3 Jaw Chuck Rotary Attachment

The optional Fusion Galvo G100 3-Jaw Chuck Rotary Attachment allows you to mark and engrave on cylindrical objects.



An important note: Always power off the machine before installing or uninstalling the Rotary Attachment. The Fusion Galvo G100 laser system will not recognize the Rotary Attachment until the system is rebooted, and you could damage the electronics if the rotary is installed while the laser system is powered on.



Note: Using the IRIS™ Camera to place artwork on the rotary is not suggested. The circumferential view from the camera makes the artwork placement difficult.



3-Jaw Rotary and Additional Components

The following fixture plates and additional components are included with all 3-Jaw Rotary Attachments

1. 3-Jaw Rotary
2. 3-Jaw tightening pins (2 each)
3. Red cap fasteners (from shipping brackets).

Rotary Attachment Installation

1. Raise the Galvo platform far enough so the Rotary Attachment will not interfere with the platform.
2. With the Fusion Galvo **powered off**, mate the cable connector to the plug located at the left side of the cabinet as shown in the photo.
3. Once the Rotary Attachment cable is connected, you can power on the laser system. The Fusion Galvo senses that the Rotary has been installed.



SECTION 9: OPTIONAL FEATURES

4. Fasten the Rotary Attachment to the center point on the Galvo G100 table. For reference turn on the red dot pointer to align the rotary base plate properly. See photos below for reference.

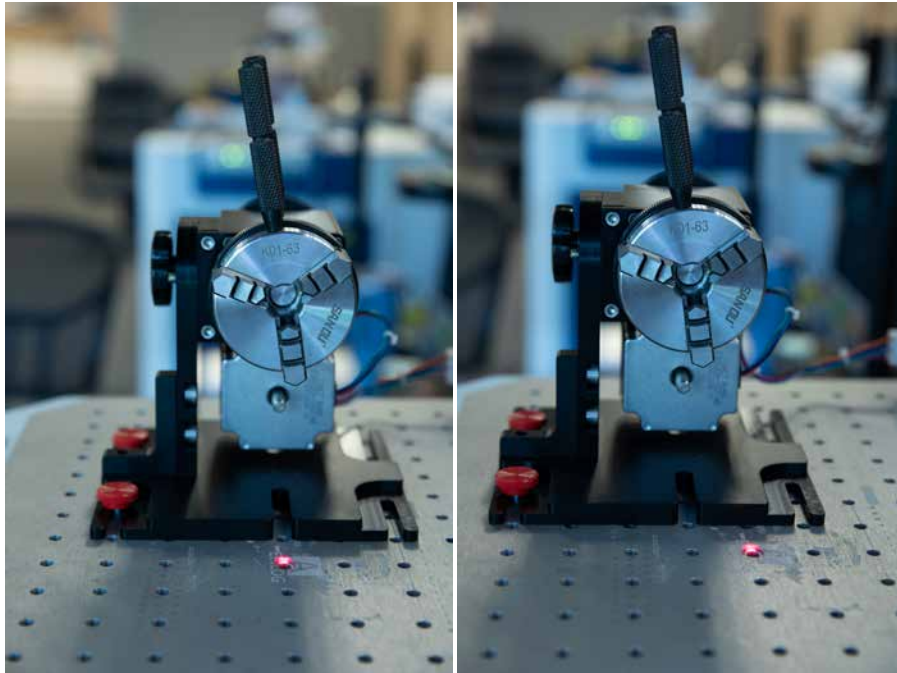

Correct

Incorrect

3-Jaw Chuck Rotary Attachment Setup

1. **Measure your cylinder:** The cylinder diameter will be used in the print driver.



SECTION 9: OPTIONAL FEATURES

2. **Clamp your cylinder:** Insert your cylinder into the 3-Jaw Chuck and tighten the chuck so the cylinder is held firmly in place.

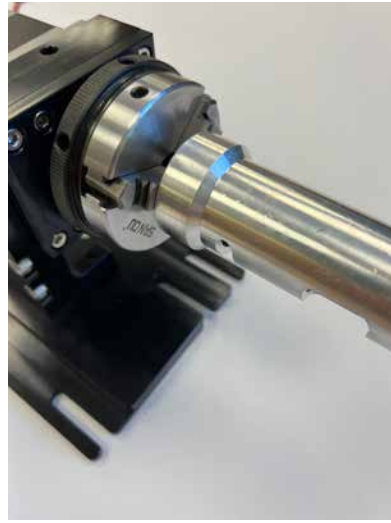
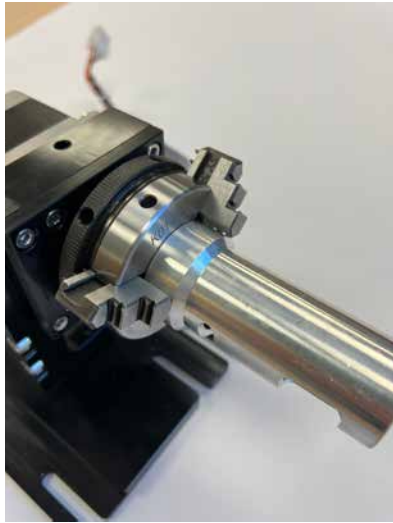

Cylinders can be held from the outside diameter (left picture) or the inside diameter (right picture).

You will need to use the two tightening pins that are provided with the chuck in order to clamp the cylinder tightly into place.



SECTION 9: OPTIONAL FEATURES

Setting Focus with the 3-Jaw Attachment

There are 3 different ways to set focus with the 3-Jaw Rotary attachment.

1. With your cylinder in place on the Rotary Attachment, press the **Focus Menu** button on the control panel.

Raise or lower the Galvo platform until the single red dot pointer is positioned on top of the visible red cross hair.

2. Use the Manual Focus gauge by moving the part and rotary to position under the manual focus hanger. Then raise or lower the Galvo platform until the manual focus gauge touches the part.

When you are finished focusing, remove the Manual Focus Gauge and press the **Reset** key on the Touch Screen.

3. With the item secured in the 3-Jaw rotary, measure the distance from the galvo table to the top of the item. Input that measurement in the display panel Focus function by moving the Galvo platform up or down using the joystick. A caliper will offer the best accuracy for this measurement



3-Jaw Chuck Size Ranges (inches)

The maximum length that will fit in the G100 is 13" (330.2mm).

Inside Diameter (ID)	Inside Diameter (ID)	Outside Diameter (OD)	Outside Diameter (OD)
Minimum	Maximum	Minimum	Maximum
0.82" (21mm)	3.25" (82mm)	0.05" (1.27mm)	3" (76mm)

SECTION 9: OPTIONAL FEATURES

Setting Engraving/Mark Location

At the control panel, press the **Jog Menu** icon. Using the Joystick (1) with the red dot point ON, move the red dot to the desired position on the item to be marked. Once you have selected the correct position for the engraving/mark location, press the **Centering Point** icon (2). Once you have set the new Centering Point, press the **Done** button (3) on the Display Panel to return to the Job Menu.



Note: Up and down motion of the joystick will rotate the part in the 3-Jaw Rotary. Left and right joystick movement will move the lens assembly left and/or right along the axis of the part to be engraved/ marked.



Using the f Theta 163 lens will require the position of the red dot within 4 inches of table center, and 6 inches within table center with the f Theta 254 lens. Mark position outside of this area will result in a Centering Error on the display panel.



Set the Cylinder Diameter in the Dashboard

With the rotary installed, the diameter measured, and the cylinder held tightly in place, you are ready to print.

1. Print your job to the Epilog Dashboard.
2. In the **Advanced tab**, turn the **Rotary** selection to “ON”.

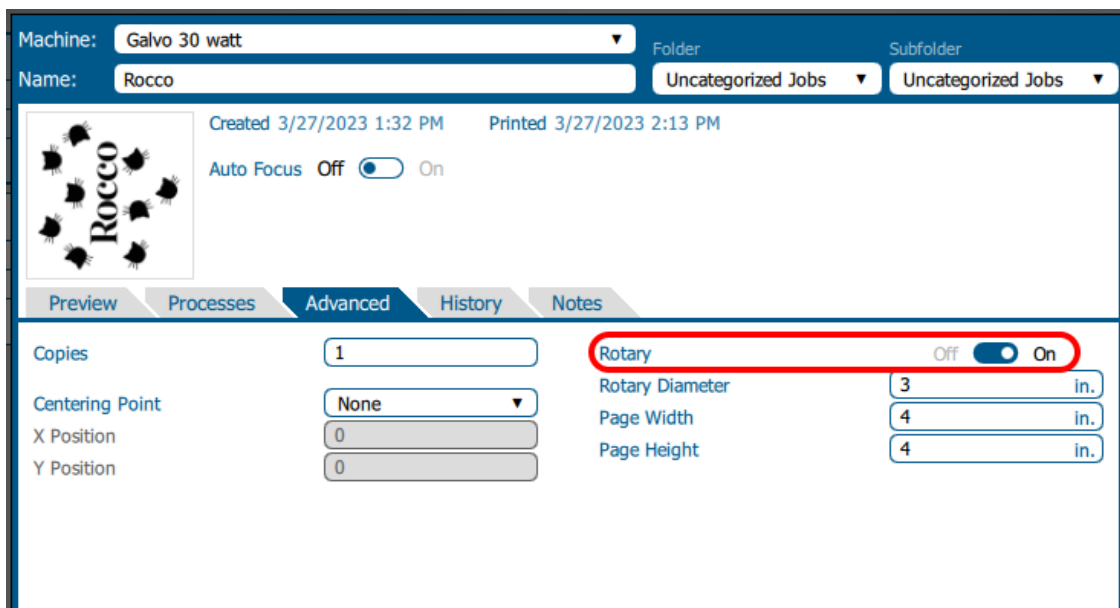

SECTION 9: OPTIONAL FEATURES

3. Input the diameter of the cylinder. Calculate the part circumference (part diameter x 3.1416). Set the page height to be slightly larger than the circumference. Example: Part diameter = 2.7" and circumference = 8.49" Set page height to 9".

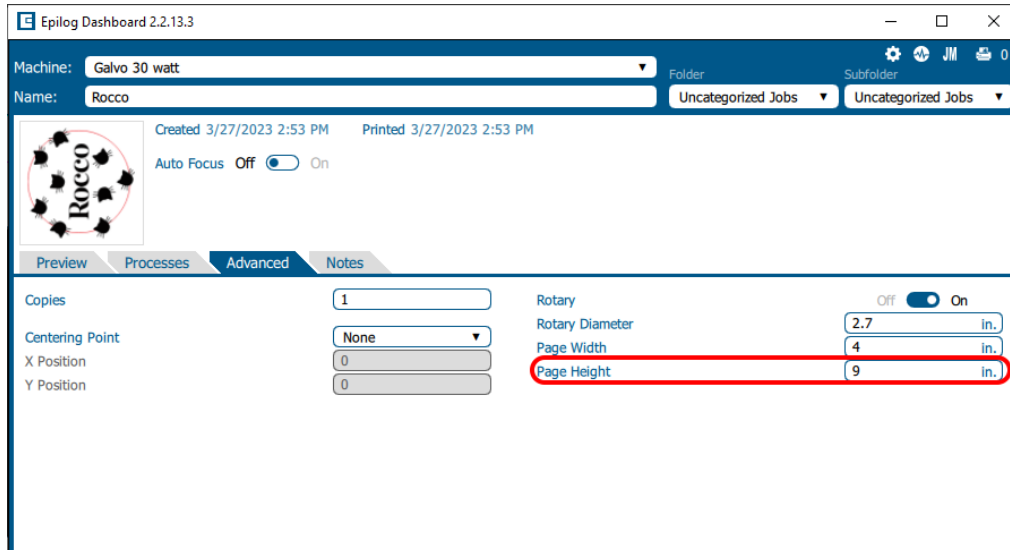

Artwork Layout for Center-Center Positioning

Artwork layout and positioning is a three-step process when using the 3-Jaw Chuck Rotary:

1. Setting up your artwork in your graphics software.
2. Setting the Laser processes in the Dashboard
3. Setting the **Centering Point** option in the **Advanced tab** of the Dashboard. This will tell the machine that you are going to manually center the artwork over the cylinder you are engraving.

SECTION 9: OPTIONAL FEATURES

1. Set up a custom page size in your graphic software that will accommodate the length and circumference of your cylinder. To set up your page, measure the length of the cylinder you are engraving. Use this as the minimum size of the horizontal dimension of your page. Measure the diameter of your cylinder and multiply this number by Pi (3.1416) to determine the circumference of the cylinder. Use the circumference as the minimum size of the vertical dimension of your page. The actual size of the page is not overly important. If you have a cylinder that's 5.23" long with a circumference of 2.3", use a page that's slightly larger, say, 6" x 3".

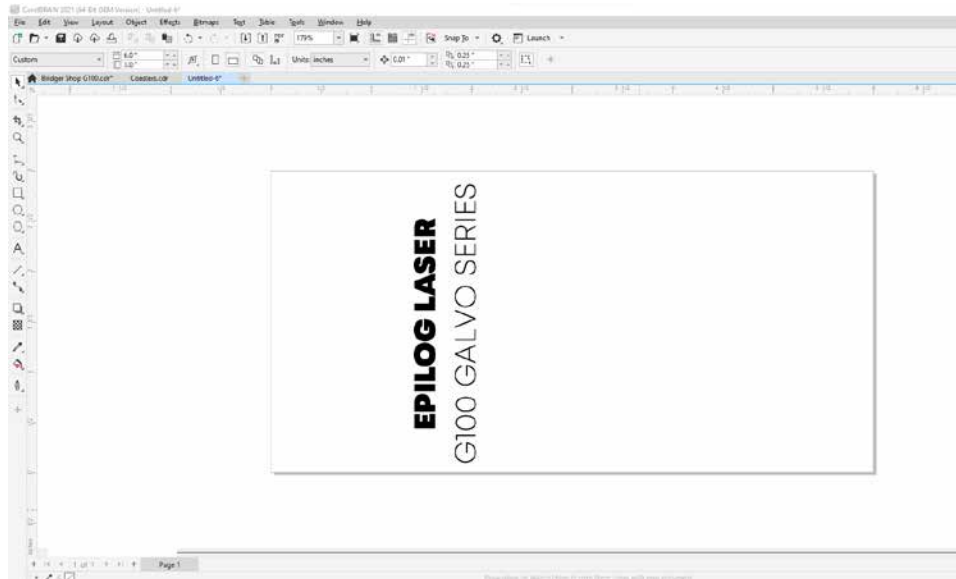

This image shows a page size of 6" x 3". The gray inner rectangle represents the cylinder that is 5.23" x 2.3". Ensure your work fits within the cylinder size.

2. Place your artwork anywhere within the grey area of the page and Print to the Epilog Dashboard. It is not overly important where you place the artwork in the grey area of the page. Your artwork will be positioned by using the Centering Point function in the Dashboard's Advanced tab and centering the carriage over your cylinder.
3. Set your laser processes in the **Preview tab**.

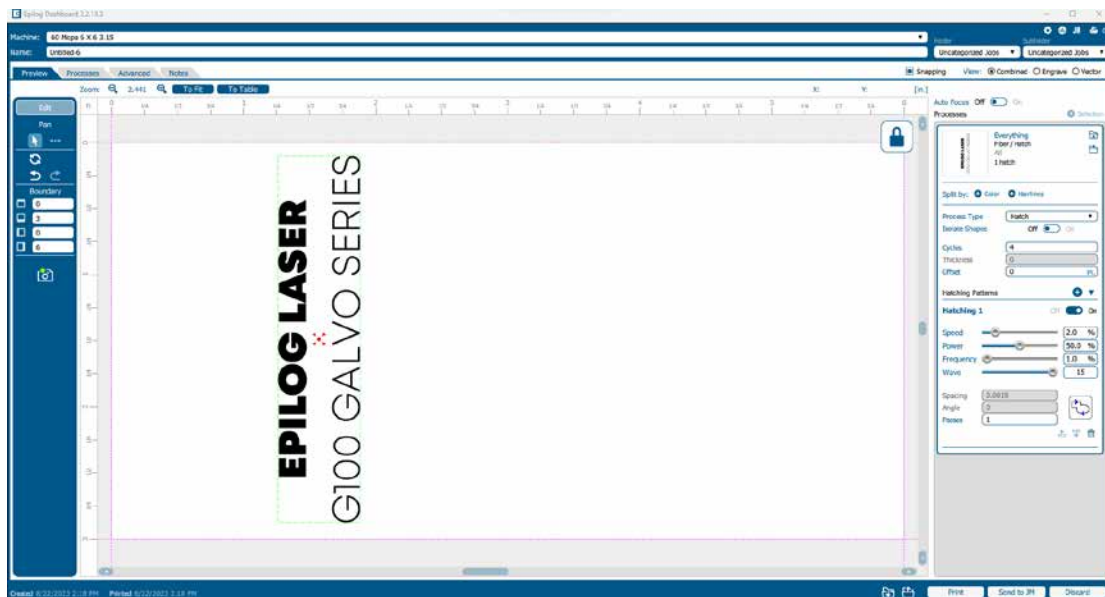

SECTION 9: OPTIONAL FEATURES

4. In the **Advanced** tab, turn on the **Rotary** setting, and set the **Centering Point** to the desired Centering function and print your job to the laser.

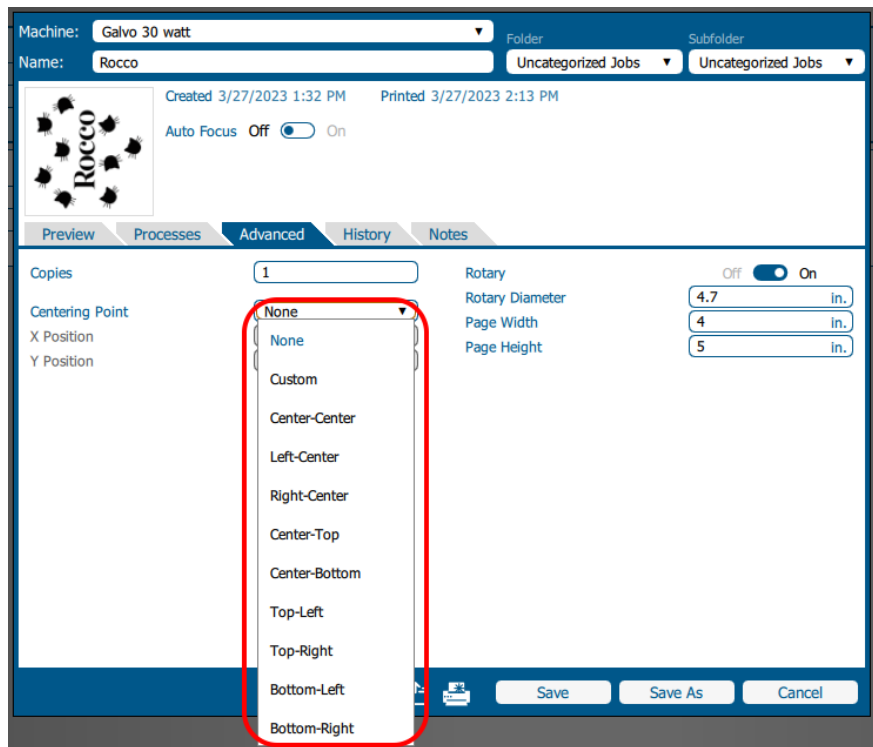

Rotary Removal

1. Turn off the power to the laser.
2. Depress the release tab on the connector and unplug the connector.
3. Unscrew the red cap fasteners from the table.
4. Remove the Rotary Attachment.

SECTION 9: OPTIONAL FEATURES

Different Configurations for Fixturing Cylinders



Outside



Inside

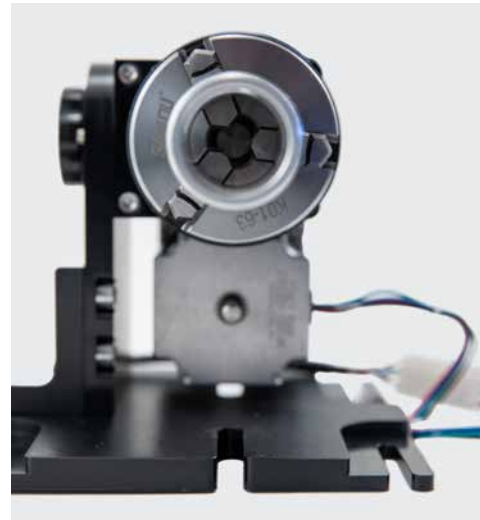

Note: The dial knob can be loosened, allowing the 3-jaw to be tilted so the item being held is level, as shown below:

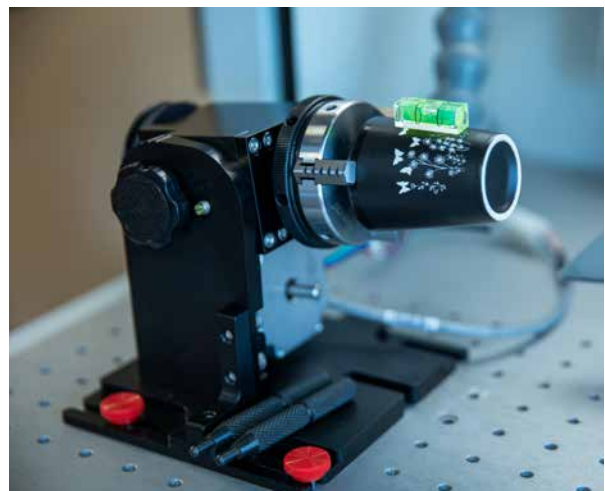

SECTION 9: OPTIONAL FEATURES

3-Jaw Chuck Quick Start Guide

1. Raise the Galvo platform far enough to accommodate the Rotary Attachment.
2. Turn off the machine, the door will stay open.
3. Measure the diameter of the item you are engraving, then attach it to the rotary.
4. Plug in the Rotary Attachment and position it in the center of the table using the red cap fasteners.
5. Power up your laser.
6. Focus – There are three ways to set the proper focus using the 3-jaw rotary attachment on the G100 laser system:
 1. Press the **Focus Menu** button on the control panel and align the single red dot over the red light crosshairs on the item to be engraved.
 2. Place the **Manual Focus Gauge** on the gauge hanger (attached to bottom of galvo platform) and move the rotary so that the item fixed in the 3-jaw rotary is below the focus gauge. Raise or lower the galvo platform until the gauge touches the item. Move the rotary back to the proper marking location at the center of the table.
 3. With the item secured in the 3-Jaw rotary, measure the distance from the Galvo table to the top of the item. Input that measurement in the display panel Focus function by moving the galvo platform up or down using the joystick. A caliper will offer the best accuracy for this measurement
7. Set Home Position
 - Press the **Jog Menu** button on the Control Panel.
 - Use the Joystick to move the red pointer to the point on your cylinder where you want your Home Position to be located.
 - Click on the **Centering Point** icon to set the new Home Position, then press **Done**.
8. Set up your artwork and print to the Epilog Dashboard.
9. Use the Epilog Dashboard (**Preview tab** and **Advanced tab**) to set your laser parameters.
 - Select **Center-Center** engraving mode in the **Advanced tab**.
 - Turn on the Rotary setting in the **Advanced tab**.
 - Input your cylinder diameter in the **Advanced tab**.
 - Set your Speed, Power, and other laser parameters in the **Preview tab**.
 - Print the job to the laser.
10. From the Display panel, select your job and press the Go button to start your job. The door will automatically close before running the job.

Helpful Tips & Limitations

- Using Hatch Mode with the Rotary Attachment only works with hatch angles of 0 degrees.

SECTION 10: UPGRADING FIRMWARE

How to Upgrade Your Firmware

Your laser system is capable of having its operational firmware upgraded. The firmware is the command software in your laser system that controls how your laser system operates. A firmware upgrade reprograms your laser system to take advantage of new capabilities or enhancements to the system. The steps for upgrading the Fusion Galvo firmware are explained below.

Note: Choose a time that's convenient for you to update the firmware, updates can take up to 10 minutes depending on the size of the update file.

Upgrading your laser is a two-step process:

1. Download the new firmware to your computer and unzip it.
2. Transfer the new firmware from your computer to your laser.

Downloading New Firmware onto Your Computer

Start by checking your current firmware version by powering on the laser. The current version is displayed on the **Settings** menu, which is accessible by pressing the **gear icon** in the upper right corner of the screen. Then click on **“Version”** to view the current Firmware version number.

Downloading: From the Epilog website download the new firmware under **Support + Service > Driver and Firmware Downloads** and save the Fusion Galvo firmware file.



You can also join our Driver Notification mailing list on the download page to be automatically notified when new versions of firmware or the driver become available.

When you download the firmware it comes as a compressed file in the following format: **X.X.X.zip**. The X's designate the actual version of the firmware. Once downloaded, unzip the file by right-clicking on the file and selecting **“Unzip To”** or **“Extract To”**.

You will need to pay attention to the folder it is extracted to:



Important! Keep track of the folder where you saved the extracted **.swu update file**. You will need to access this file again in the next step.

Transferring New Firmware from Your Computer to Your Laser

When transferring the updated firmware file to your laser you have two options:

1. Transfer by USB
2. Transfer by Ethernet Cable

USB Transfer

1. Load the .swu update file onto a USB drive from your computer. **We recommend using an empty USB drive** to find the update file easily.



Note: It's easiest if you put the update file in the root directory of your USB drive. If the update file is not located in the root directory of the USB drive, the machine may not detect the update file automatically. If you decide to put the update file into its own folder, make sure the folder name contains no spaces.

2. Eject the USB Drive with the update file from your computer.

SECTION 10: UPGRADING FIRMWARE

3. Plug the USB drive into the Fusion Galvo and it will detect the drive as it powers on. The machine will ask if you would like to update. Press **“Yes”**.

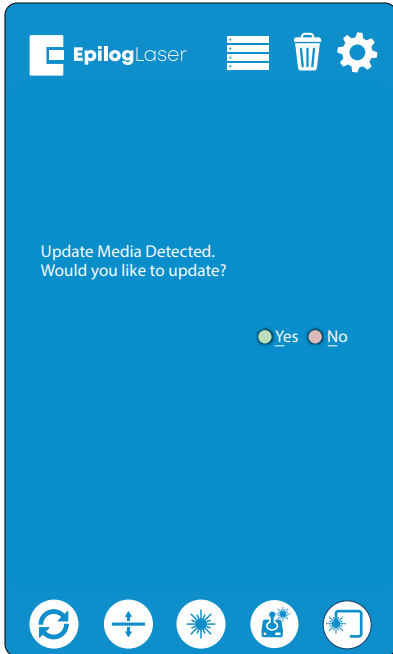

Note: If this screen does not appear after plugging in your USB drive, the update file is not being automatically detected by the machine. You may reboot the machine while pressing down on both the **joystick** and **Go/Stop** button until the screen goes blank. This will cause the machine to boot into **Update Mode**.

4. The machine will need to reboot to run in **Update Mode**. Turn the machine off and then back on again.

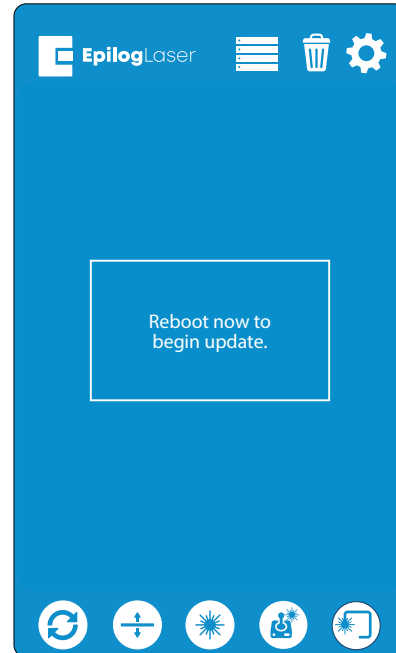

5. Once the machine has booted back up, you will see a screen with three options: USB Update, Update Network, or Cancel.

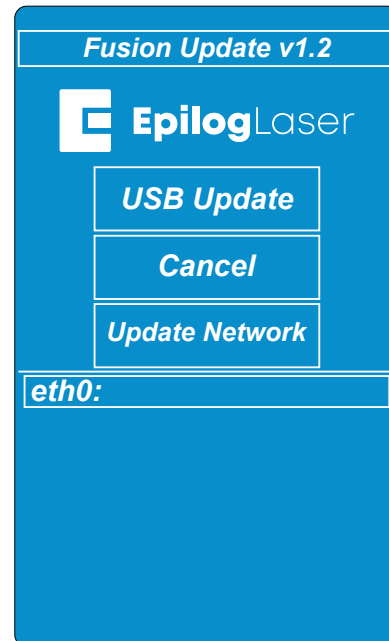

SECTION 10: UPGRADING FIRMWARE



Note: Canceling will prompt you to power cycle the machine to reboot into the current firmware version you have loaded on the machine.

6. Select **“USB Update”** and a directory folder should appear showing your .swu update file. Select the file **fpvX.X.X.X.update.swu** and then select **“Open”**.

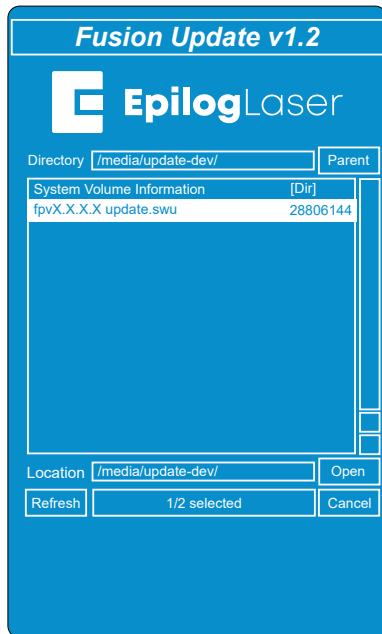

7. The update should begin and may take up to 10 minutes, depending on the size of the update file. Keep track of the time the update begins.



Important: The screen may turn off temporarily while updating, sometimes for several minutes. Please **DO NOT** turn off the machine in the middle of an update! The update is still active if the **LED light number 4** is flashing on the system status light panel located on the right side of the machine.

8. Once the update has completed you will see **“Success”** on the screen. Click **“Ok”**.

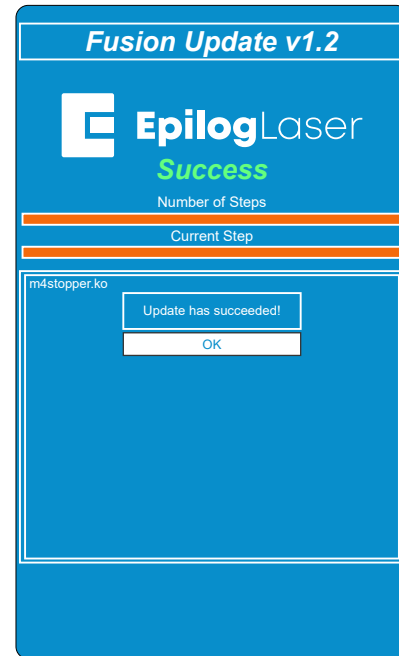

9. The next screen will prompt you to power cycle in order to boot into the new firmware. Turn the machine off, unplug the USB drive, and then turn the machine back on again.

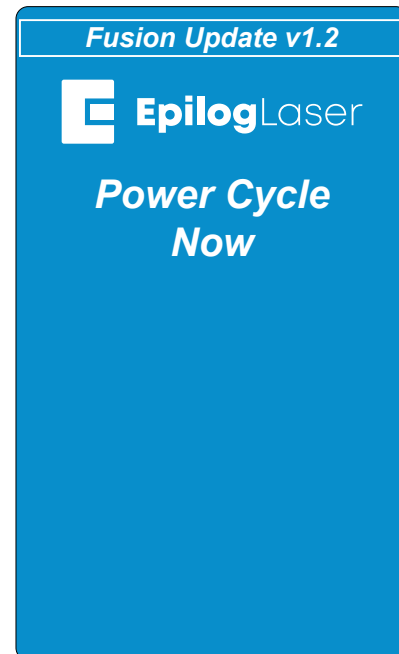

10. Your firmware update should now be complete once the machine boots up.

SECTION 10: UPGRADING FIRMWARE

Ethernet Transfer

1. With an Ethernet cable you may transfer the firmware update file (.swu) directly from your computer to the machine. Please make sure the Ethernet cable is plugged in completely on both ends.
2. Power on the machine and press down both the **joystick** and **Go/Stop** button until the screen goes blank. This will cause the machine to boot into **Update mode**.



3. Open your web browser and in the search bar, type "**http://**" followed by the IP address currently displayed on the Fusion Galvo's screen next to "eth0:". After the IP address, add "**:8080**" and hit "**Enter**".

Example: http://192.168.3.4:8080



Note: If there is no IP address next to "eth0:", Ethernet transfer will not work.

4. A screen will load on your computer's web browser with a box to drag and drop the update file into.

5. Put the .swu file in the upload box and this will initiate the update.

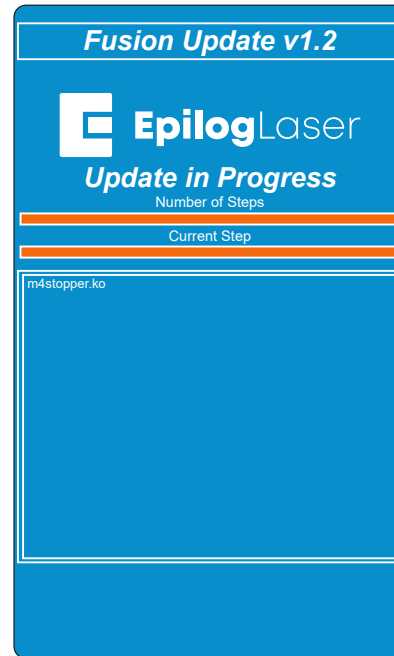

6. Once the update has completed you will see "Success" on the screen. Press "**OK**".

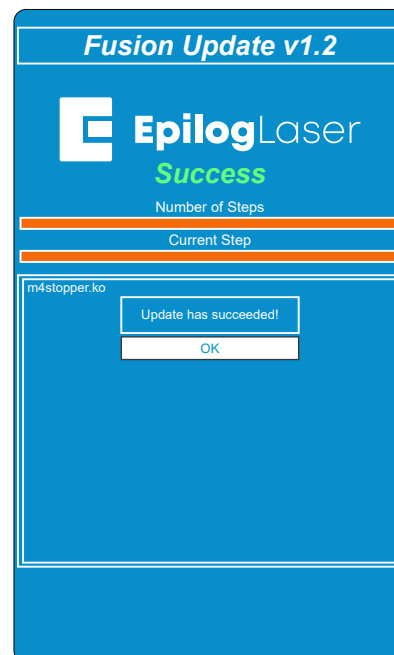

SECTION 10: UPGRADING FIRMWARE

7. The next screen will prompt you to power cycle the machine in order to boot into the new firmware. Turn the machine off and then back on again.

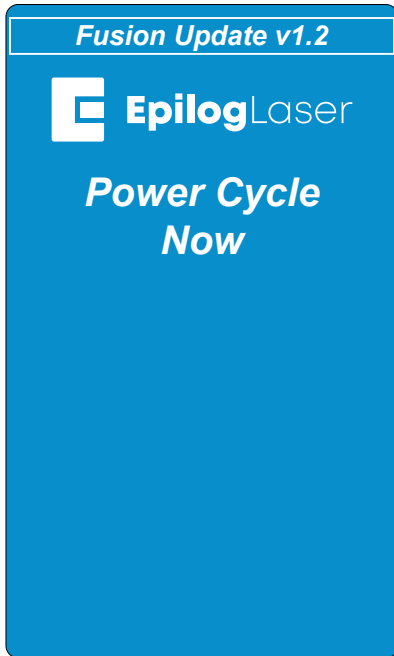

8. Your firmware should now be updated and be ready to use once the machine boots up.

SECTION 11: ENGRAVING MATERIALS

Fiber Laser Materials/Techniques

The fiber laser can etch and mark a wide variety of metals and plastics. Below are a few techniques for creating different marks including annealing, polishing and etching into metals, as well as information on plastic marking with the fiber laser.

Metal Annealing

Annealing can be done on most metals that contain high levels of carbon and metal oxides. These are generally, but not limited to, steel alloys, iron, titanium, cobalt, molybdenum, and chrome-plated iron/steel. To anneal, you must use a slow rate of speed to heat and change the surface color of the material, but a higher wattage fiber laser will help reduce the cycle times.

To change the surface color without penetrating the metal, the laser beam's focal point is crucial in achieving a dark mark. An annealed mark is accomplished with the focal point up (closer to) .070" to .110" (1.778 to 2.794 mm) or down (further away) -.060" to -.090" (-1.524 to -2.286 mm) from zero. Adjusting the speed, focus and frequency setting will vary the contrast of mark generally resulting in shades of blue, purple and black.

The frequency is the amount of laser power per pulse. The lower the frequency, the more burst of power is being applied. Because we're intentionally applying a broader beam of laser light to achieve an annealed mark, frequency is almost always set in the lower 1-5% range.

For best results, print at 600 DPI. 1200 DPI should be considered for metals that are more difficult to anneal, if there is inconsistent color change at the recommended settings, or when cycle times aren't a concern. The extra overlapping of pixels offered at 1200 DPI will assure a deeper, darker mark.

Metal Etching

Deep metal engraving is a common application for the fiber laser. Using a slow speed setting doesn't necessarily equate to depth. Longer laser dwell time typically results in more eruption of metal, leaving a raised mark instead of deep penetration.

We find for the best deep metal etching, moderate speed settings (20-30%) and more passes slowly chip away at the metal for a better mark. Deep metal engraving requires maximum wattage. For these applications, a 30 or 50-watt fiber laser is recommended.

Frequency is generally set between the 1-5% range. A lower frequency range provides more bursts of laser power per pulse and is crucial to ablating the metal. We've found that focusing "into" the metal by .010" to .030" (.254 to .762 mm) helps in the removal of metal. No technical data is available on whether refocusing after each pass is helpful or not. To better assist in removing metal cleanly, higher resolution (1200 DPI) with more overlap of laser pulses tends to provide a cleaner, more defined etch.

Deep engraving will require multiple passes, which can be easily accomplished by changing the number of copies in the print dialogue box for CorelDRAW. As with all materials including metals, the hardness or grade will ultimately determine what settings and how many passes are needed to achieve a certain depth. Use the guidelines above as starting points and experiment for best results.

SECTION 11: ENGRAVING MATERIALS

Metal Polishing

Polishing of metals is accomplished by quickly heating up the metal's surface, changing its color, resulting in a mirror-like finish. Polishing can be done on just about any metal including, but not limited to, raw alloys, heat-treated metals, plated metals and precious metals.

For a high-contrast mark, polishing is best done on darker, matte finish metals. Cleaning the surface prior to processing is recommended as oils, grease and other chemicals can affect the consistency and finish of the final marks. Dialing in the settings for a polished mark is the most difficult of the three most popular metal marking techniques. Speed, power and frequency play the biggest role.

- Speed is generally set on the high side, 50-100%, depending on wattage.
- The power is set in the 30-60% range, depending on wattage.
- Frequency is also set on the higher side, typically around the 50-100% range. A higher frequency setting equates to less power per laser pulse. Too strong of a laser pulse and the laser beam starts penetrating the metal instead of polishing, resulting in a dull or browning effect.

Focus should be set at zero. Printing resolution is in the range of 300 to 600 DPI but is mostly done at 400 or 600.

Start by determining your base speed, frequency and resolution setting. From there, select a power setting and start fine tuning by adjusting the power in 1% increments or decrements.

Plastic Marking

The term “plastics” is commonly used to describe various grades and types of polymers. To keep things simple, we'll refer to all polymers as plastic. There are many plastics that are compatible with the fiber laser's 1062 nm wavelength of light. We refer to these as “engineered plastics” because many were designed to be laser-etched at some point during the manufacturing life cycle. These plastics are doped with an additive that results in a contrasting mark when the 1062nm wavelength of light is applied.

There are many other plastics that work just as well as the engineered ones. It's amazing how many different plastics we receive for applications testing, most of the time their trade name and chemical composition aren't disclosed or are unknown. The guidelines below will help in your quest to provide the best possible mark.

Most plastics that tend to work on the FiberMark are those that are mold-injected and are physically hard. Industries where injection molded parts are common include automotive, aerospace, medical device and general manufacturing, to name a few.

Some of the more common compatible plastics include PET, ABS, polycarbonate and colored delrin. Some that are more difficult to mark using this wavelength of light include polyethylene, polypropylene and nylon.

Settings for processing plastics:

- Moderate to fast speed, typically in the 50-80% range.
- Moderate power, generally around the 30-60% range, depending on wattage.

SECTION 11: ENGRAVING MATERIALS

- Medium to high frequency (50-100%) is helpful for processing plastics as it provides a steadier stream of laser power per pulse. Using a low frequency would result in inconsistent contrast and possibly cause foaming of the surface.
- Focus is generally left at zero. Adjusting the focus up or down in .010" (0.254 mm) increments can provide slightly better contrast but instead, consider adjusting the speed / power / frequency for the same effect.

Most plastics are processed at 600 DPI for high contrast and detail. Cycle times are generally fast, so dropping the resolution would only affect print quality. Increasing resolution may prove helpful only on those plastics that are difficult to mark. The majority of compatible plastics will provide a high-contrasting mark using the above settings. Darker plastics will turn white or varying shades of gray. Lighter plastics will turn dark gray to black. Fine tune the mark by increasing/decreasing power or frequency. Speed and focus can be left alone.

Incompatible plastics will either be transparent to the 1062 nm wavelength of light or will require the use of metal marking settings (low to medium speed, high power, and low frequency). The final mark for these plastics isn't as appealing, consistent or contrasting as their compatible counterparts.

Pigmentation of plastic can also dictate what settings are needed to produce a nice mark. The core polymer may be compatible, but due to chemicals used to add color, some colors may mark better than others. Having to adjust the printing parameters for different colors of the same compatible plastic is not uncommon.

SECTION 12: SPECIFICATIONS

Fusion Galvo Laser Technical Specifications

	Fusion Galvo (F163 lens)	Fusion Galvo (F254 lens)
Maximum Engraving Area	4" x 4" (101 x 101 mm)	6" x 6" (152 x 152 mm)
Max Material Thickness	10" (254 mm)	6" (152 mm)
Laser Source Wattages	30-watt pulsed, 30-watt MOPA, or 60-watt MOPA fiber configurations. Fiber, air-cooled, 1064nm.	
Standard Features	Radiance High Definition Optics (CO2), Air Assist, Red Dot Pointer, relocatable Home Position, LED lighting, integrated floor stand, brushless servo motors, Super-Silent Cooling Fans, Joystick controls, removable exhaust plenum.	
Intelligent Memory Buffer	Multiple files up to 1GB. Engrave any file size.	
Operating Modes	Optimized Raster, Vector & Combined modes.	
Motion Control System	High-speed, continuous-loop, brushless DC servo motors using rotary encoding technology for precise positioning.	
X-axis Bearings	Ground & polished stainless steel, Teflon-coated, self-lubricating bearings.	
Resolution	Fully-flexible and user-controlled from 75 to 1200 DPI.	
Speed and Power Control (engraving depth)	Computer-controlled speed & power in .001 increments up to 100%. Color mapping feature links speed, power, frequency, and raster/vector mode.	
Print Interface	USB, Wireless, & 1000Base-T Ethernet connections. Windows 7/8/10 compatible.	
Size (W x D x H)	28" x 23" x 31" (door closed) 37" height (door open) 711mm x 584mm x 787mm / 940mm	
Weight	131 lbs (59.5 kg)	
Electrical Requirements	Auto-switching 110 to 240 volts, 50 or 60 Hz, single phase, 15 amp AC	
Exhaust Requirements	450-650 CFM (764-1104 m3/hr) external exhaust to the outside or internal filtration unit required.	
Exhaust Ports	One output Port 4" (102 mm) diameter.	
Laser System Classification	Class 2 Laser Product - 1 mW CW Maximum 600-700 nm.	

Technical specifications and product configurations subject to change without notice.

SECTION 13: TECHNICAL SUPPORT

Contacting Technical Support

The technical support department at Epilog is available to assist with solving problems you may encounter using your Epilog. Please review first the common problems and solutions as noted below, then if you are still in need of assistance you may contact Epilog’s technical support department at the number or website listed below. Technical support is available in Golden, Colorado USA during the hours of 6 a.m. and 6 p.m. Mountain Time.



Technical Support Direct Line: 1 (303) 215-9171
Email: tech@epiloglaser.com
Technical Support Online: support.epiloglaser.com

What to do prior to contacting Epilog Technical Support:

1. Have the machine serial number available.
2. Have time to work on machine. Many issues will require troubleshooting.
3. Clean your machine (especially the optics), this will solve many issues.

The machine serial number can be found on the Certification/Identification Label. This engraved plate is located on the back of the machine’s cabinet. The ID label shown is for the Model 18000 product.



Note: You can also find your machine’s Serial Number in the Settings Menu under “About Machine”.

SECTION 13: TECHNICAL SUPPORT

Join Epilog Laser's Online Community

Find out the latest Epilog news, keep in touch with our customers, and stay connected through our social media channels!



Facebook page: www.facebook.com/epiloglaser
Fan page: www.facebook.com/groups/75753849193/



Youtube channel: www.youtube.com/epiloglaser



Twitter: www.twitter.com/EpilogLaser



Instagram: www.instagram.com/epiloglaser/



Pinterest: www.pinterest.com/epiloglaser/



LinkedIn: www.linkedin.com/company/epilog

APPENDIX A: WARRANTY STATEMENT

Warranty Statement for the Fusion Galvo Laser

Epilog Corporation warrants to the original purchaser of Epilog Fusion Model 18000 that the product will be free from defects in material or workmanship when purchased, and under proper, normal use within two (2) years from the original date of purchase.

Epilog will replace or, at its option, repair the defective part(s). Normally, Epilog will supply a replacement part for the customer to replace. Once the replacement has been performed, the replaced part must be returned to Epilog. In the case where repair is required, Epilog requires that the defective part, or machine, be returned to the Epilog factory or other Epilog designated facility. Epilog will be responsible solely for the cost of repairs, including parts and labor, which are made at an authorized Epilog facility. All other costs for replacement or repair, including, but not limited to, packaging and shipping both to and from Epilog, shall be paid by the owner. A "Core" charge may be required by Epilog to insure the return of replacement and repair parts. This warranty excludes any damage from abuse (including, without limitation, incorrect voltages, power surges, fires, improper or insufficient ventilation "acts of God" or other situations out of the control of Epilog), failure to operate in accordance with instructions provided in the Owner's Manuals for the Epilog model 18000, including specific safety and operational warnings contained therein, cosmetic damage sustained in use, and damage caused by unauthorized modifications of any equipment. All warranties to original purchasers are non-transferable. The registered owner must initiate warranty claims within the warranty period.

THE ABOVE AND FOREGOING IS THE ONLY WARRANTY OF ANY KIND, EITHER EXPRESS OR IMPLIED; INCLUDING BUT NOT LIMITED TO ANY WARRANTIES OF MERCHANTABILITY AND FITNESS FOR A PARTICULAR PURPOSE, THAT ARE MADE BY EPILOG ON MODEL 18000. ANY WARRANTIES IMPLIED BY LAW ARE HEREBY EXPRESSLY DISCLAIMED.

No oral or written information or advice given by Epilog, its dealers, its distributors, agents, officers, or employees shall create a warranty or in any way increase the scope of this warranty. Neither Epilog nor anyone else who has been involved in the creation, production, or delivery of the Epilog Fusion Models 18000 shall be liable for any direct, indirect, consequential, or incidental damages, including but not limited to damages for loss of business profits, business interruption, loss of business information, adverse health impacts, fire, and the like, arising out of the use or inability to use these products.

Epilog Corporation provides no warranties whatsoever on any software used in connection with Epilog Fusion Model 18000.

APPENDIX B: MATERIAL SETTINGS

Fusion Galvo Suggested Material Settings (F163 Lens)			
Material	30 watt pulsed	30 watt MOPA	60 watt MOPA
Aluminum (Anodized)			
Etching/Marking	Angle: 0 / 90 Speed: 100% Power: 75% Frequency: 1% / 25% Focus: 0 Spacing: 0.002 Cycles: 1	Angle: 45 / 90 Speed: 100% Power: 60% Frequency: 1% Waveform: 10 Focus: 0 Spacing: 0.002 Cycles: 1	Angle: 45 / 90 Speed: 100% Power: 35% Frequency: 1% Waveform: 6 Focus: 0 Spacing: 0.0015 Cycles: 1
<p>The contrast / brightness of marks achievable on the fiber laser are excellent and can often be much brighter than marks from a CO2 laser. Taking the fiber laser out of focus by +.03" - .09" broadens the beam and produces a very bright mark on anodized coating. Lower frequency and higher power settings help offset the change in focal point. Different grades of anodized & core aluminum alloy will affect how the final marks look.</p>			
Aluminum (Bare)			
Polishing	Angle: 45 / 90 Speed: 70% / 100% Power: 85% / 60% Frequency: 15% / 25% Focus: 0 Spacing: 0.002 Cycles: 1	Angle: 45 / 90 Speed: 100% Power: 50% / 40% Frequency: 1% Waveform: 6 Focus: 0 Spacing: 0.0015 Cycles: 1	Angle: 45 Speed: 70% Power: 50% Frequency: 1% Waveform: 15 Focus: 0 Spacing: 0.002 Cycles: 1
<p>Engraving aluminum will result in various shades of gray, not black. Fine tuning the settings can provide a bit more contrast but the range of applicable marks is very narrow. If the application calls for a black etch, consider using an oxidizer after engraving. Oxidizers are used most commonly if the aluminum has a protective coating (urethane, clear coat, clear anodized) covering the area that is not engraved. Deep metal engraving on aluminum can be done using multiple passes. Consider deep engraving and using a black epoxy/color fill. Although the marks on aluminum are not black like they are on steel, we have no difficulty getting 2D, UID barcodes to scan and verify.</p>			
Laserable Plastic			
Black Plastic	Angle: 90 / 45 / 0 Speed: 100% Power: 20% Frequency: 1% Focus: 0 Spacing: 0.0025 Cycles: 1	Angle: 90 Speed: 100% Power: 45% Frequency: 1% Waveform: 5 Focus: 0 Spacing: 0.002 Cycles: 1	Angle: 45 Speed: 100% Power: 40% Frequency: 1% Waveform: 5 Focus: 0 Spacing: 0.002 Cycles: 1
White Plastic (Polystyrene)	Angle: 90 Speed: 100% Power: 65% Frequency: 45% Focus: 0 Spacing: 0.002 Cycles: 1	Angle: 0 Speed: 100% Power: 50% Frequency: 1% Waveform: 6 Focus: 0 Spacing: 0.003 Cycles: 1	Angle: 45 Speed: 100% Power: 45% Frequency: 1% Waveform: 6 Focus: 0 Spacing: 0.003 Cycles: 1

APPENDIX B: MATERIAL SETTINGS

Fusion Galvo Suggested Material Settings (F163 Lens)			
Material	30 watt pulsed	30 watt MOPA	60 watt MOPA
Black Acrylic (White mark)	n/a	Angle: 45 / 90 Speed: 100% Power: 65% Frequency: 1% Waveform: 4 Focus: 0 Spacing: 0.0025 Cycles: 1	Angle: 45 / 90 Speed: 100% Power: 50% Frequency: 1% Waveform: 4 Focus: 0 Spacing: 0.0025 Cycles: 1
Stainless Steel			
Annealing	Angle: 90 Speed: 20% Power: 100% Frequency: 1% Focus: 0.175 Spacing: 0.0002 Cycles: 1	Angle: 90 Speed: 20% Power: 100% Frequency: 1% Waveform: 15 Focus: 0.15 Spacing: 0.00015 Cycles: 1	Angle: 90 Speed: 35% Power: 100% Frequency: 1% Waveform: 6 Focus: 0.15 Spacing: 0.0001 Cycles: 1
<p>Etching: Like our CO2 counterparts, the slower the speed setting, the deeper the etching. However, many metal applications can be processed at higher speed settings. Again, consider the marking requirements.</p> <p>Annealing: To achieve an annealed mark, the focal point should be significantly away from zero. The unfocused, broader beam provides the heat to change the surface color without actually penetrating the metal. The focal point can be either closer to or away from zero. Focusing away from the material should be in the range of .060" to .090". Focusing closer to the material is generally in the range of -.070" to -.110". Both focusing methods will result in annealing of the metal. Focusing up typically results in a slight indentation of the metal. Multiple passes can darken the mark even more (no data to confirm whether multiple passes offer more permanency).</p> <p>Polishing: Some steel alloys are easier to polish than others. For best results, clean off the surface with alcohol prior to processing. Any leftover grease, oils or residue can affect how well the polished mark turns out. Polishing the metal where the final marks result in a bright white engraving requires finer tuning of settings, more so than the etched or annealed marks. Determine a base speed and frequency setting and adjust the power in small increments/decrements. If you are unable to get a white bright mark, increase the frequency setting and try again by adjusting only the power.</p>			
Titanium			
Annealing	Angle: 90 Speed: 20% Power: 100% Frequency: 1% Focus: 0.175 Spacing: 0.0002 Cycles: 1	Angle: 90 Speed: 20% Power: 100% Frequency: 1% Waveform: 15 Focus: 0.15 Spacing: 0.00015 Cycles: 1	Angle: 90 Speed: 35% Power: 100% Frequency: 1% Waveform: 6 Focus: 0.15 Spacing: 0.0001 Cycles: 1

APPENDIX B: MATERIAL SETTINGS

Fusion Galvo Suggested Material Settings (F163 Lens)			
Material	30 watt pulsed	30 watt MOPA	60 watt MOPA
<p>Titanium and Ti alloys are highly amenable to marking at this wavelength. Similar to aluminum, a black mark from the etching process is difficult to achieve. Various shades of gray can be made, from very dark gray to light gray. Annealed marks can also be made on titanium materials using the same processing parameter described for stainless steel. Depending on the Ti alloy, marks of various colors can be achieved by changing the frequency values for 1% up to 100%. It is common to see red, blue, green, orange, yellows and purple marks, depending on the frequency selected.</p>			
Metals			
Etching/Marking	Angle: 0 / 45 / 90 / 315 Speed: 25% Power: 100% Frequency: 1% Focus: 0 Spacing: 0.0015 Cycles: 1	Angle: 0 / 45 / 90 / 315 Speed: 100% Power: 100% Frequency: 1% Waveform: 15 Focus: 0 Spacing: 0.0015 Cycles: 1+	Angle: 0 / 45 / 90 / 315 Speed: 50% Power: 100% Frequency: 1 Waveform: 15 Focus: 0 Spacing: 0.0015 Cycles: 1+
Polish	Angle: 45 / 90 Speed: 70% / 100% Power: 85% / 60% Frequency: 15% / 25% Focus: 0 Spacing: 0.002 Cycles: 1	Angle: 45 / 90 Speed: 70% Power: 85% / 70% Frequency: 15 Waveform: 15 Focus: 0 Spacing: 0.002 Cycles: 1	Angle: 0 Speed: 70% Power: 50% Frequency: 40 Waveform: 15 Focus: 0 Spacing: 0.002 Cycles: 1
<p>Metals are often plated to assist with conductivity, to provide a protective coating against rust and elements and for aesthetic purposes. Plating thickness will depend on application and purpose. Most of the plated metals processed through the applications lab are electronic components (to enhance conductivity) and various fittings (protection against environment & rust). The typical plating thickness varies from .001" up to .005". Our recommended settings for general metal engraving works well for ablating through the plating; exposing the base metal. Ablating the plating will also provide high contrast. Using an oxidizer will enhance the look.</p> <p>Our recommended settings for polishing of metals are a good starting point where ablating through the plating isn't an option. This is likely the most common plated metal application as exposing the raw metal underneath will break continuity and / or expose the bare metal to rust and other elements. Note that the contrast of polishing of plated metals won't be as consistent or contrasting as a direct ablation. Multiple passes will help and end results will vary based on the metal used for plating, thickness of plating & size of mark. Our recommended settings for annealing will often work for plated metals where the plating has a thicker wall and material used has high levels of carbon or metal oxides.</p>			

APPENDIX B: MATERIAL SETTINGS

Powder Coating			
Etching/Marking	Angle: 90 / 45 / 315 Speed: 50% / 50% / 100% Power: 100% / 100% / 50% Frequency: 1% / 1% / 25% Focus: 0 Spacing: 0.0015 Cycles: 1	Angle: 45 / 90 / 315 Speed: 50% / 100% Power: 100% / 100% / 50% Frequency: 1% Waveform: 15 / 12 / 10 Focus: 0 Spacing: 0.0015 Cycles: 1	Angle: 45 / 90 Speed: 50% Power: 100% Frequency: 1% Waveform: 15 Focus: 0 Spacing: 0.0015 Cycles: 1
Two to three passes are suggested (one pass to ablate the powder coating, 2nd or 3rd pass to polish up the metal underneath). A little less power, higher frequency and less focus adjustment will be required for the 2nd or 3rd pass, depending on the base metal. The idea is to ablate then polish. An alternative to running two or more passes is to run one pass and then use a common cleaner such as Simple Green or a citric-based cleaner with short, stiff bristle brush to scrub out the residual material remaining in the mark area. If using this technique, it may be necessary to raise or lower the marking table from around 0.07" to 0.10".			
Painted Metal			
Polish	n/a	Angle: 0 / 45 Speed: 100% Power: 50% Frequency: 1% Waveform: 4 Focus: 0 Spacing: 0.002 Cycles: 1	Angle: 0 / 45 Speed: 100% Power: 45% Frequency: 1% Waveform: 4 Focus: 0 Spacing: 0.002 Cycles: 1
Deep Metal Engraving			
	Angle: 0 / 45 / 90 / 315 Speed: 20% Power: 100% Frequency: 1% Focus: 0 Spacing: 0.0015 Cycles: 4+	Angle: 0 / 45 / 90 / 315 Speed: 50% Power: 100% Frequency: 1% Waveform: 15 Focus: 0 Spacing: 0.0015 Cycles: 4+	Angle: 0 / 45 / 90 / 315 Speed: 50% Power: 100% Frequency: 1% Waveform: 15 Focus: 0 Spacing: 0.0015 Cycles: 4+
Multiple passes. Slower speeds tend to erupt material rather than ablate. You may also enhance the edges by running 2-5 passes of the outline of the artwork at 50% Speed / 100% Power / 1% Frequency & 15 Waveform.			

- **These are only guidelines:** Brightness or darkness of a mark is a matter of personal preference and can be very dependent of the type of material being marked. As such, there is no “correct” setting. Working with the four different fiber settings becomes fairly intuitive in a very short period of time for most users. If you have a material that is not listed, try to compare it to similar materials listed and use those settings as your starting point.
- **Speed Settings:** The speed setting scale of 1% to 100% is not linear – i.e. 100% speed will not be twice as fast as 50% speed. This non-linear scale is very useful in compensating for the different factors that affect engraving time.
- **Power Settings:** The power settings are linear – i.e. 50% power is half as much as 100% power.
- **General Metal Engraving / Base Settings:** In the world of metals the grade, type, hardness and chemical composition are endless. Metal alloys are engineered for specific applications and have their own strengths and weaknesses. Metals can be engraved at just about any settings. Of course, there are many variables to consider for metal engraving. The lasers wattage, hardness of metal, desired mark (etch, polish, anneal) and the required time/contrast/depth will have to be considered when deciding on the final settings.

APPENDIX B: MATERIAL SETTINGS

- **General Annealing Settings:** Producing an annealed mark is very dependent on the material being out of focus. Run the laser at slow speed and full power then adjust the focus while the machine is running until you achieve the annealed mark you need.
- **Test your material:** If you do not achieve the results you are looking for with the recommended settings, try resending the job and start by changing only one variable at a time. Changing only one variable at a time will help to determine the correct setting for your material.
- Laser settings can sometimes be confusing because many materials can be marked over such a broad range of settings. If you have difficulty in finding the correct setting you can send a sample to the Epilog Laser Applications lab. We will determine if the material can be marked and provide appropriate setting for your laser.



- To print a copy of these settings to keep next to your laser, go to www.epiloglaser.com/material-settings.

APPENDIX B: MATERIAL SETTINGS

Fusion Galvo Suggested Material Settings (F254 Lens)			
Material	30 watt pulsed	30 watt MOPA	60 watt MOPA
Aluminum (Anodized)			
Etching/Marking	Angle: 0 / 90 Speed: 100% Power: 75% Frequency: 1% / 25% Focus: 0 Spacing: 0.002 Cycles: 1	Angle: 45 / 90 Speed: 100% Power: 60% Frequency: 1% Waveform: 10 Focus: 0 Spacing: 0.002 Cycles: 1	Angle: 45 / 90 Speed: 100% Power: 50% Frequency: 1% Waveform: 10 Focus: 0 Spacing: 0.002 Cycles: 1
The contrast / brightness of marks achievable on the fiber laser are excellent and can often be much brighter than marks from a CO2 laser. Taking the fiber laser out of focus by +.03" - .09" broadens the beam and produces a very bright mark on anodized coating. Lower frequency and higher power settings help offset the change in focal point. Different grades of anodized & core aluminum alloy will affect how the final marks look.			
Aluminum (Bare)			
Polishing	Angle: 45 / 90 Speed: 70% / 100% Power: 85% / 60% Frequency: 15 / 25% Focus: 0 Spacing: 0.002 Cycles: 1	Angle: 45 / 90 Speed: 100% Power: 70% Frequency: 1% Waveform: 6 Focus: 0 Spacing: 0.0015 Cycles: 1	Angle: 0 / 90 Speed: 100% Power: 50% / 35% Frequency: 1% Waveform: 6 Focus: 0 Spacing: 0.0015 Cycles: 1
Engraving aluminum will result in various shades of gray, not black. Fine tuning the settings can provide a bit more contrast but the range of applicable marks is very narrow. If the application calls for a black etch, consider using an oxidizer after engraving. Oxidizers are used most commonly if the aluminum has a protective coating (urethane, clear coat, clear anodized) covering the area that is not engraved. Deep metal engraving on aluminum can be done using multiple passes. Consider deep engraving and using a black epoxy/color fill. Although the marks on aluminum are not black like they are on steel, we have no difficulty getting 2D, UID barcodes to scan and verify.			
Laserable Plastic			
Black Plastic	Angle: 90 / 45 / 0 Speed: 100% Power: 20% Frequency: 1% Focus: 0 Spacing: 0.0025 Cycles: 1	Angle: 45 Speed: 100% Power: 45% Frequency: 1% Waveform: 5 Focus: 0 Spacing: 0.002 Cycles: 1	Angle: 45 Speed: 100% Power: 30% Frequency: 1% Waveform: 5 Focus: 0 Spacing: 0.0025 Cycles: 1
White Plastic (Polystyrene)	Angle: 90 Speed: 100% Power: 60% Frequency: 45% Focus: 0 Spacing: 0.002 Cycles: 1	Angle: 45 Speed: 100% Power: 55% Frequency: 1% Waveform: 6 Focus: 0 Spacing: 0.003 Cycles: 1	Angle: 45 Speed: 100% Power: 50% Frequency: 25% Waveform: 4 Focus: 0 Spacing: 0.003 Cycles: 1

APPENDIX B: MATERIAL SETTINGS

Fusion Galvo Suggested Material Settings (F254 Lens)			
Material	30 watt pulsed	30 watt MOPA	60 watt MOPA
Black Acrylic (White mark)	n/a	Angle: 45 / 90 Speed: 100% Power: 55% Frequency: 1% Waveform: 4 Focus: 0 Spacing: 0.0025 Cycles: 1	Angle: 45 / 90 Speed: 100% Power: 40% Frequency: 1% Waveform: 4 Focus: 0 Spacing: 0.003 Cycles: 1
Stainless Steel			
Annealing	Angle: 90 Speed: 20% Power: 100% Frequency: 1% Focus: 0.25 Spacing: 0.0002 Cycles: 1	Angle: 90 Speed: 35% Power: 75% Frequency: 1% Waveform: 10 Focus: 0.2 Spacing: 0.0001 Cycles: 1	Angle: 90 Speed: 35% Power: 75% Frequency: 1% Waveform: 10 Focus: 0.2 Spacing: 0.0001 Cycles: 1
<p>Etching: Like our CO2 counterparts, the slower the speed setting, the deeper the etching. However, many metal applications can be processed at higher speed settings. Again, consider the marking requirements.</p> <p>Annealing: To achieve an annealed mark, the focal point should be significantly away from zero. The unfocused, broader beam provides the heat to change the surface color without actually penetrating the metal. The focal point can be either closer to or away from zero. Focusing away from the material should be in the range of .060" to .090". Focusing closer to the material is generally in the range of -.070" to -.110". Both focusing methods will result in annealing of the metal. Focusing up typically results in a slight indentation of the metal. Multiple passes can darken the mark even more (no data to confirm whether multiple passes offer more permanency).</p> <p>Polishing: Some steel alloys are easier to polish than others. For best results, clean off the surface with alcohol prior to processing. Any leftover grease, oils or residue can affect how well the polished mark turns out. Polishing the metal where the final marks result in a bright white engraving requires finer tuning of settings, more so than the etched or annealed marks. Determine a base speed and frequency setting and adjust the power in small increments/decrements. If you are unable to get a white bright mark, increase the frequency setting and try again by adjusting only the power.</p>			
Titanium			
Annealing	Angle: 90 Speed: 20% Power: 100% Frequency: 1% Focus: 0.25 Spacing: 0.0002 Cycles: 1	Angle: 90 Speed: 35% Power: 75% Frequency: 1% Waveform: 10 Focus: 0.2 Spacing: 0.0001 Cycles: 1	Angle: 90 Speed: 35% Power: 75% Frequency: 1% Waveform: 10 Focus: 0.2 Spacing: 0.0001 Cycles: 1

APPENDIX B: MATERIAL SETTINGS

Fusion Galvo Suggested Material Settings (F254 Lens)			
Material	30 watt pulsed	30 watt MOPA	60 watt MOPA
<p>Titanium and Ti alloys are highly amenable to marking at this wavelength. Similar to aluminum, a black mark from the etching process is difficult to achieve. Various shades of gray can be made, from very dark gray to light gray. Annealed marks can also be made on titanium materials using the same processing parameter described for stainless steel. Depending on the Ti alloy, marks of various colors can be achieved by changing the frequency values for 1% up to 100%. It is common to see red, blue, green, orange, yellows and purple marks, depending on the frequency selected.</p>			
Metals			
Etching/Marking	Angle: 0 / 45 / 90 / 315 Speed: 20% Power: 100% Frequency: 1% Focus: 0 Spacing: 0.0015 Cycles: 1	Angle: 0 / 45 / 90 / 315 Speed: 20% Power: 100% Frequency: 1% Waveform: 15 Focus: 0 Spacing: 0.0015 Cycles: 1+	Angle: 0 / 45 / 90 Speed: 75% Power: 100% Frequency: 1 Waveform: 15 Focus: 0 Spacing: 0.0015 Cycles: 1+
Polish	Angle: 45 / 90 Speed: 70% / 100% Power: 85% / 60% Frequency: 15% / 25% Focus: 0 Spacing: 0.002 Cycles: 1	Angle: 45 / 90 Speed: 70% Power: 100% Frequency: 15 Waveform: 1 Focus: 0 Spacing: 0.002 Cycles: 1	Angle: 45 Speed: 70% Power: 50% Frequency: 15 Waveform: 15 Focus: 0 Spacing: 0.002 Cycles: 1
<p>Metals are often plated to assist with conductivity, to provide a protective coating against rust and elements and for aesthetic purposes. Plating thickness will depend on application and purpose. Most of the plated metals processed through the applications lab are electronic components (to enhance conductivity) and various fittings (protection against environment & rust). The typical plating thickness varies from .001" up to .005". Our recommended settings for general metal engraving works well for ablating through the plating; exposing the base metal. Ablating the plating will also provide high contrast. Using an oxidizer will enhance the look.</p> <p>Our recommended settings for polishing of metals are a good starting point where ablating through the plating isn't an option. This is likely the most common plated metal application as exposing the raw metal underneath will break continuity and / or expose the bare metal to rust and other elements. Note that the contrast of polishing of plated metals won't be as consistent or contrasting as a direct ablation. Multiple passes will help and end results will vary based on the metal used for plating, thickness of plating & size of mark. Our recommended settings for annealing will often work for plated metals where the plating has a thicker wall and material used has high levels of carbon or metal oxides.</p>			

APPENDIX B: MATERIAL SETTINGS

Powder Coating			
Etching/Marking	Angle: 90 / 45 / 315 Speed: 50% / 50% / 100% Power: 100% / 100% / 60% Frequency: 1% / 1% / 10% Focus: 0 Spacing: 0.0015 Cycles: 1	Angle: 45 / 90 Speed: 50% Power: 100% Frequency: 1% Waveform: 15 Focus: 0 Spacing: 0.0015 Cycles: 1	Angle: 90 / 45 / 315 Speed: 100 % Power: 100% / 45% Frequency: 1% Waveform: 15 / 7 Focus: 0 Spacing: 0.0015 Cycles: 1
Two to three passes are suggested (one pass to ablate the powder coating, 2nd or 3rd pass to polish up the metal underneath). A little less power, higher frequency and less focus adjustment will be required for the 2nd or 3rd pass, depending on the base metal. The idea is to ablate then polish. An alternative to running two or more passes is to run one pass and then use a common cleaner such as Simple Green or a citric-based cleaner with short, stiff bristle brush to scrub out the residual material remaining in the mark area. If using this technique, it may be necessary to raise or lower the marking table from around 0.07" to 0.10".			
Painted Metal			
Polish	n/a	Angle: 0 / 45 Speed: 100% Power: 50% Frequency: 1% Waveform: 4 Focus: 0 Spacing: 0.002 Cycles: 1	Angle: 45 / 90 Speed: 100% Power: 50% / 45% Frequency: 1% Waveform: 8 Focus: 0 Spacing: 0.002 Cycles: 1
Deep Metal Engraving			
	Angle: 0 / 45 / 90 / 315 Speed: 20% Power: 100% Frequency: 1% Focus: 0 Spacing: 0.0015 Cycles: 4+	Angle: 0 / 45 / 90 / 315 Speed: 20% Power: 100% Frequency: 1% Waveform: 15 Focus: 0 Spacing: 0.0015 Cycles: 4+	Angle: 0 / 45 / 90 / 315 Speed: 50% Power: 100% Frequency: 1% Waveform: 15 Focus: 0 Spacing: 0.0015 Cycles: 4+
Multiple passes. Slower speeds tend to erupt material rather than ablate. You may also enhance the edges by running 2-5 passes of the outline of the artwork at 50% Speed / 100% Power / 1% Frequency & 15 Waveform.			

- **These are only guidelines:** Brightness or darkness of a mark is a matter of personal preference and can be very dependent of the type of material being marked. As such, there is no “correct” setting. Working with the four different fiber settings becomes fairly intuitive in a very short period of time for most users. If you have a material that is not listed, try to compare it to similar materials listed and use those settings as your starting point.
- **Speed Settings:** The speed setting scale of 1% to 100% is not linear – i.e. 100% speed will not be twice as fast as 50% speed. This non-linear scale is very useful in compensating for the different factors that affect engraving time.
- **Power Settings:** The power settings are linear – i.e. 50% power is half as much as 100% power.
- **General Metal Engraving / Base Settings:** In the world of metals the grade, type, hardness and chemical composition are endless. Metal alloys are engineered for specific applications and have their own strengths and weaknesses. Metals can be engraved at just about any settings. Of course, there are many variables to consider for metal engraving. The lasers wattage, hardness of metal, desired mark (etch, polish, anneal) and the required time/contrast/depth will have to be considered when deciding on the final settings.

APPENDIX B: MATERIAL SETTINGS

- **General Annealing Settings:** Producing an annealed mark is very dependent on the material being out of focus. Run the laser at slow speed and full power then adjust the focus while the machine is running until you achieve the annealed mark you need.
- **Test your material:** If you do not achieve the results you are looking for with the recommended settings, try resending the job and start by changing only one variable at a time. Changing only one variable at a time will help to determine the correct setting for your material.
- Laser settings can sometimes be confusing because many materials can be marked over such a broad range of settings. If you have difficulty in finding the correct setting you can send a sample to the Epilog Laser Applications lab. We will determine if the material can be marked and provide appropriate setting for your laser.



- To print a copy of these settings to keep next to your laser, go to www.epiloglaser.com/material-settings.

APPENDIX C: SYSTEM MAINTENANCE

Calibrating the Auto Focus

1. Run a test job with a piece of anodized aluminum. Set up a small solid square as your artwork and run the job with high speed and low power settings.
2. Once the job is running, press the Focus Menu button on the touch screen, and slightly raise and lower the table with the joystick while keeping an eye on the spark coming from the laser hitting the anodized aluminum.

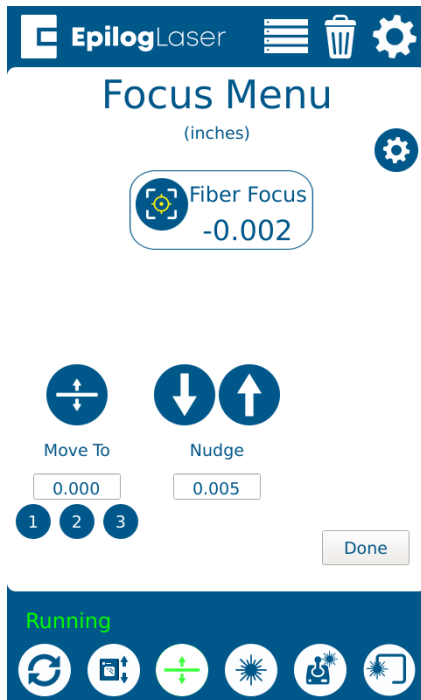

3. While raising the table up and down, find the height where the spark appears the brightest. If it's difficult to tell, turn off any overhead lights in the room.
4. Once you've found the brightest spark, let go of the joystick and press the Go/Stop button to stop the job.
5. Remove the material from the engraving bed.

6. Press the Settings button, and then long press the "Settings" text until the Advanced Settings menu appears.



APPENDIX C: SYSTEM MAINTENANCE

7. Select “Focus Commands” from the menu. Turn the “Calibration” setting ON.

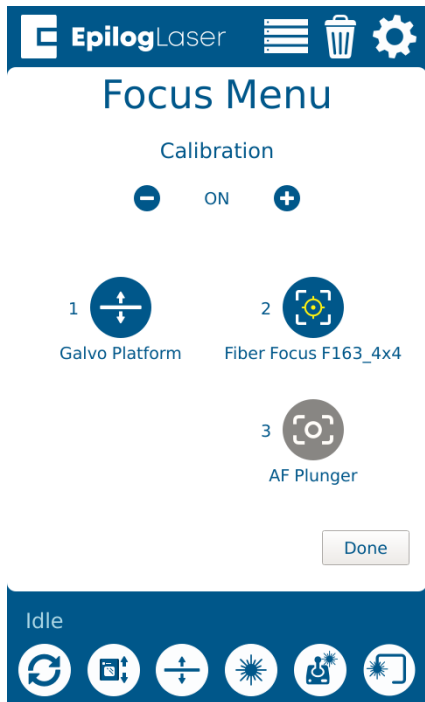

8. Select “Laser Focus”. Ensure the material thickness used during calibration is entered in the Thickness text box (The default of 0.025” corresponds to the supplied anodized aluminum). Press “Start”.

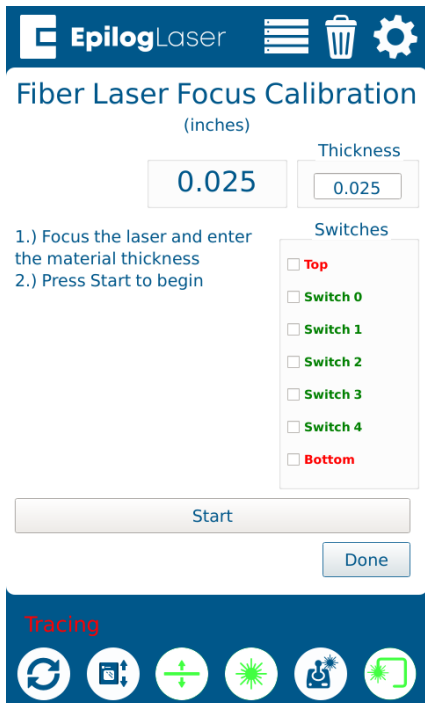

9. Once the calibration is complete, press “Done.”

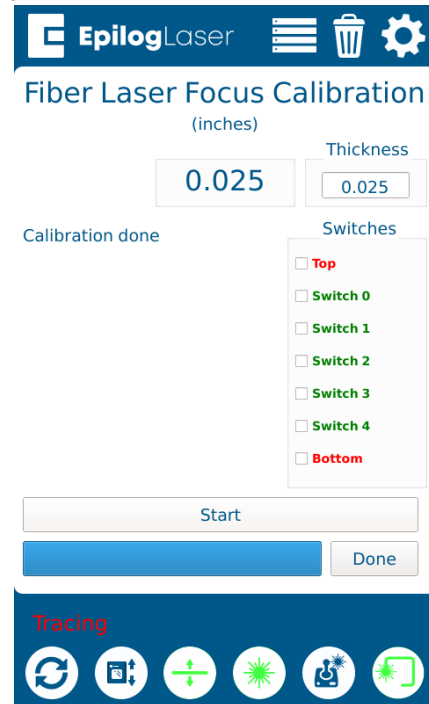

10. After calibrating the focus you will need to make sure the Red Dot Pointer lines up with the vertical line on the cross that appears while in the Focus Menu. You can do this by using a hex key in the port in the far right corner behind the lens. This will control the Red Dot Pointer’s location and is very sensitive, so making small adjustments is recommended.



11. The laser focus should now be calibrated properly.

APPENDIX C: SYSTEM MAINTENANCE

Camera Calibration



Note: Camera calibration on the Fusion Galvo is only necessary if recommended by Epilog's Technical Support.



Note: Before beginning, reboot your machine if you have recently run any jobs.



You will need an 8x8 inch piece of Anodized aluminum as well as the calibration target included with your machine to run this process.

1. Click the  **Settings** button to enter the Settings menu.

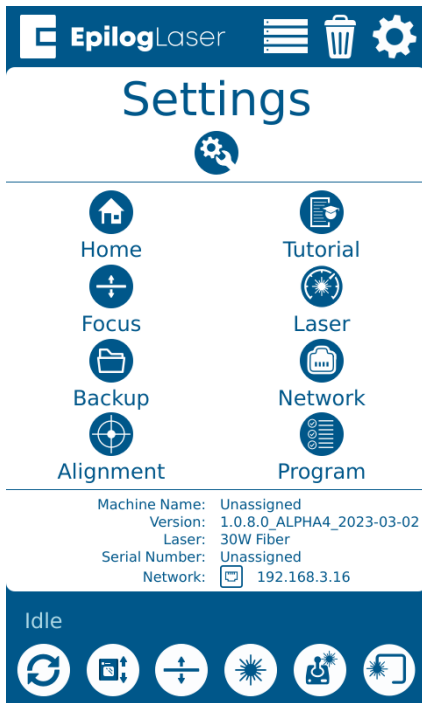

2. Long Press the **“Settings”** text for 5 seconds to enter the Advanced Settings Menu.

3. Click on **“Calibrate Cameras”** to enter the Camera Calibration menu.

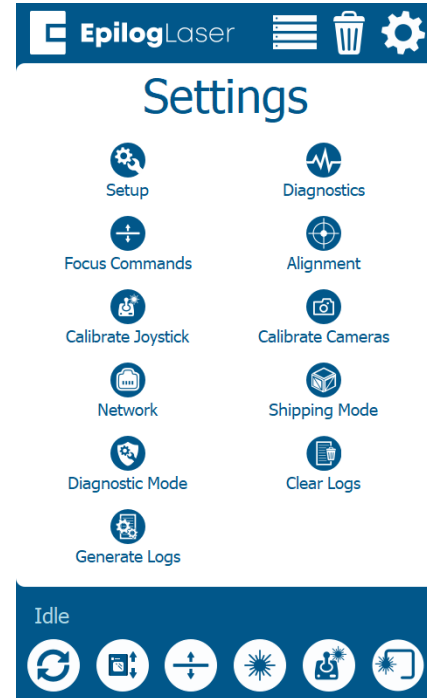

4. While the machine is Idle, follow the prompt, and begin the calibration routine by selecting **“Ok”**. Use the calibration target included with your machine.

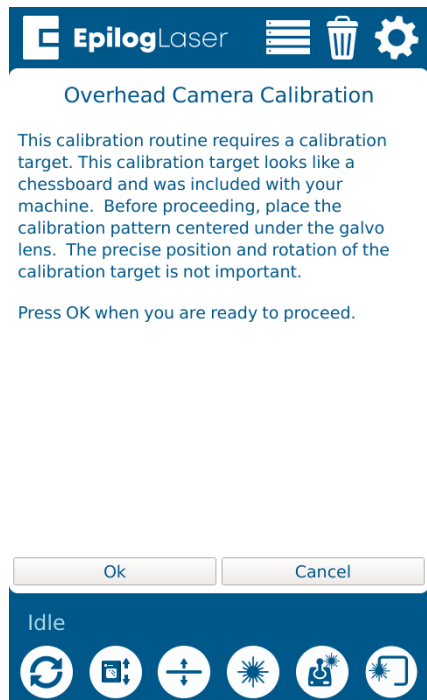

APPENDIX C: SYSTEM MAINTENANCE

5. Once the calibration target is placed on the table, press “OK” and the laser will start the calibration process.

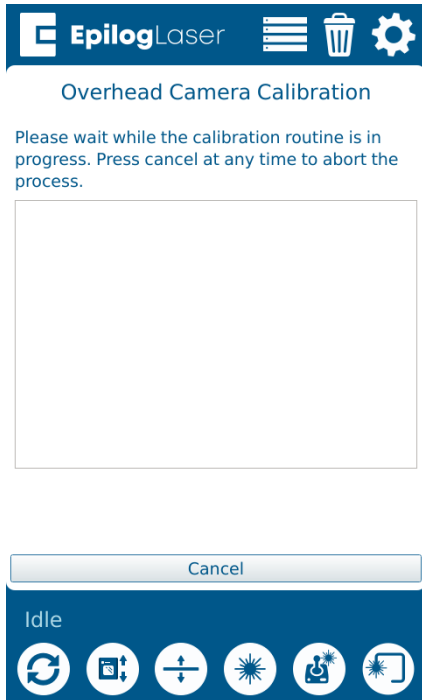

6. Allow the job to run until completion.

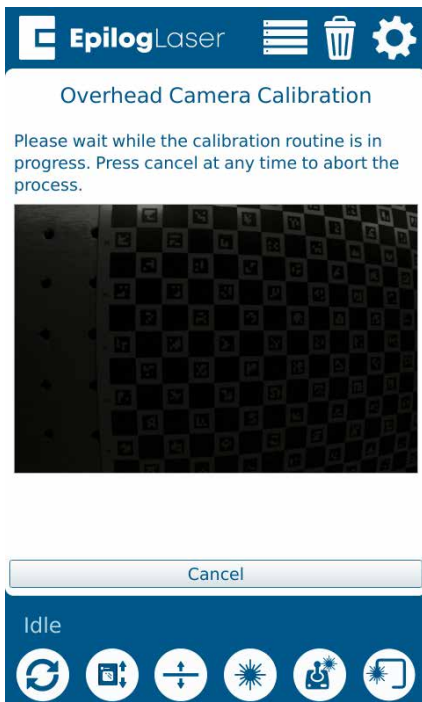

7. Once the calibration of the target has finished, you will see the following prompt. Press OK.

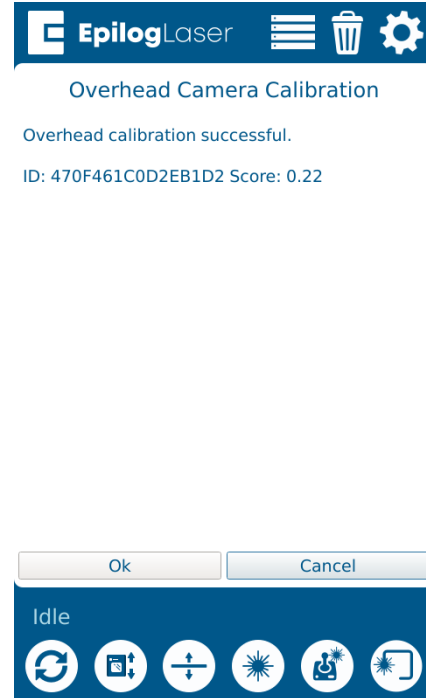

8. Now it's time to place a sheet of anodized aluminum on the table in place of the calibration target. We recommend using something to weigh down the aluminum so that it is perfectly flat

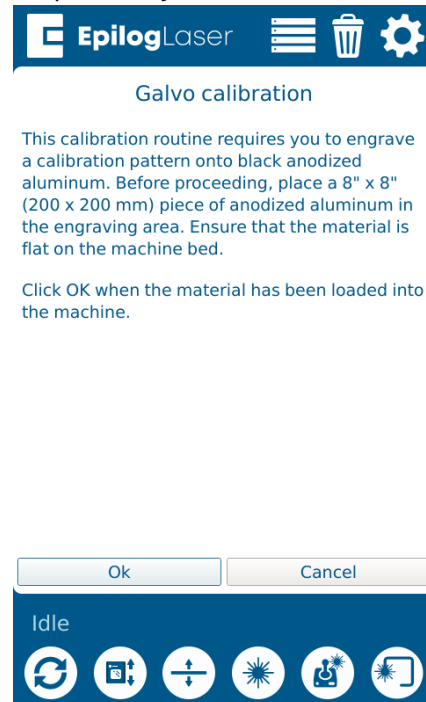

APPENDIX C: SYSTEM MAINTENANCE

9. Follow the prompt and press OK when you are ready to run the calibration job.

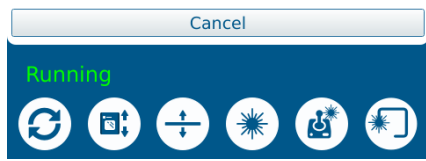

10. Allow the calibration job to run.

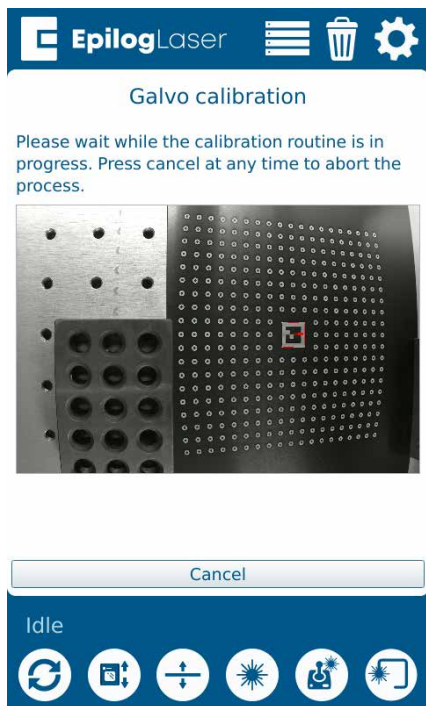

11. The camera should now be calibrated to your machine and ready to use. If the final score result is 1.3 or higher, please contact Technical Support.

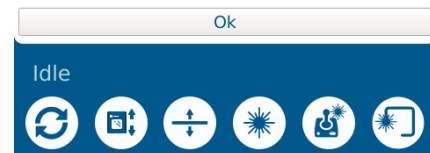

APPENDIX C: SYSTEM MAINTENANCE

Machine Settings:

- **Acceleration Match Offset [cnts]**
 - Number of encoder counts to delay firing laser when accelerating. Used for raster quality adjustments
- **Deceleration Match Offset [cnts]**
 - Number of encoder counts to delay firing laser when decelerating. Used for raster quality adjustments
- **Bed Margins [in]**
 - The margins around the bed, in inches that the carriage can travel to.
 - Format is as follows: TOP,LEFT,BOTTOM,RIGHT
- **Bed Size [in]**
 - The size of the bed in the machine in inches
 - Format is as follows: WIDTH,HEIGHT
 - Requires “Home Axis” to take effect
- **Disable Table Homing**
 - Setting to disable homing the table when the machine boots. For optimal operation, leave this at a value of 0
 - A value of 1 will disable table homing
 - Will take effect after reboot
- **Rotary Encoder [cnts/in]**
 - The number of encoder counts per inch of travel for the rotary device
 - Requires “Home Axis” to take effect
- **X Axis Encoder [cnts/in]**
 - The number of encoder counter per inch of travel for the X Axis
 - Requires “Home Axis” to take effect
 - Must recalibrate cameras if this changes
- **Y Axis Encoder [cnts/in]**
 - The number of encoder counter per inch of travel for the Y Axis
 - Requires “Home Axis” to take effect
 - Must recalibrate cameras if this changes
- **Home Offset [in]**
 - The offset of the table origin, relative to the X and Y limit switches
 - Requires “Park Axis” to take effect
 - Must recalibrate cameras if this changes
- **Joystick Center X**
 - The center X position of the joystick, in joystick units
- **Joystick Center Y**
 - The center Y position of the joystick, in joystick units
- **Joystick Deadzone [%/100]**
 - The percentage of dead zone around the center of the joystick
- **Joystick Limit X**
 - The MIN and MAX limits for the X axis of the joystick, in joystick units
 - Format is as follows: MIN,MAX
- **Joystick Limit Y**
 - The MIN and MAX limits for the Y axis of the joystick, in joystick units
 - Format is as follows: MIN,MAX
- **Laser Match [cnts]**
 - Adjustment to synchronize left to right and right to left raster lines. Units are in number of encoder counts
- **Laser Match Offset [cnts]**
 - Offset of the raster data in X. Used to align raster and vector if needed. Units are in number of encoder counts
- **Velocity Match Offset [cnts]**
 - Offset of the raster data proportional to velocity. Units are in number of encoder counts
- **Park Position [in]**
 - The position in inches to park the laser head when the machine is idle
 - Requires “Park Axis” to take effect
- **Plunger Offset [cnts]**
 - The number of table encoder counts from the laser zero focus position, to the auto focus plunger
- **Rotary Offset [in]**
 - The offset of the rotary origin, relative to the X and Y limit switches
- **Rotary Table Height [in]**
 - The distance in inches to clear the rotary device
- **Scale [mm/in]**

APPENDIX C: SYSTEM MAINTENANCE

- A scale factor to adjust the scale of the X and Y axis
- Format is as follows: X,Y
- Requires “Home Axis” to take effect
- Must recalibrate cameras if this changes
- **Table Switch Locations [cnts]**
 - A list of the locations in which the table switches were located
- **Table Current [A]**
 - The current in Amps to run the table drive
- **Table Resolution [cnts/in]**
 - The number of encoder counts per inch of travel for the table
 - Must “Home Table” if this value is changed
- **CO2 Tickle Duration [us]**
 - The duration of the laser tickle pulse in microseconds
- **CO2 Tickle Frequency [Hz]**
 - The frequency of the laser tickle pulse in hertz
- **CO2 Tickle Holdoff [us]**
 - The duration in which the laser tickle is stalled after a laser pulse in microseconds
- **CO2 Pulse Stretch [us]**
 - The amount to stretch all laser pulses in microseconds
- **Table Focus Offset [cnts]**
 - The distance in table encoder counts from the top crash switch, to the laser focus position
- **RHS Y Skew [cnts]**
 - The number of encoder counts to skew the right hand side of the Y axis after homing
 - Requires “Home Axis” to take effect
- **Air Assist Delay [s]**
 - The number of seconds to delay turning ON and turning OFF the air assist before and after a job finished
 - Format is as follows: ON,OFF

INDEX

Index

Symbols

- 3-Jaw Chuck Rotary Attachment
 - Configurations 119
 - Quick Start Guide 120
 - Removal 118
- 21 CFR 1040 9

A

- AGPL Ghostscript. *See* Software Installation
- Air Assist 104
- Air-Cooled 16
- Air Filter. *See* Exhaust Fan
 - Laser Tube 16
- Air Temperature 16
- Aluminum (Bare) 137, 142
- Anodized Aluminum 137, 142
- ANSI 8
- Artwork Setup 99
- Auto Focus 67

B

- Bearings 131
- Beziers 70
- Boundary 72

C

- Calibration 147
 - Auto Focus Calibration 147
- Camera System. *See* IRIS Camera Positioning System
- Centering Point 95
- Certification/Identification Plate 9
- Color Mapping. *See* Split by Color
- Control Panel 89
 - Delete Button 92
 - Display 89
 - Focus 90
 - Focus Menu 96
 - Go/Stop Button 89
 - Job Storage 97
 - Joystick 97
 - Pointer 91
 - Reset Key 90
- Cooling Requirements 16
- CorelDraw Setup
 - Vector Line Width 100
- CorelDRAW Setup 62, 67

- Cycles 70

D

- Dashboard 61
 - Auto Focus 67
 - CorelDRAW Features 88
 - Dividing Your Job Into Processes
 - Split by Hairline 73
 - Split by Selection 74
 - Editing Artwork with Live View 77
 - Guidelines 83
 - Merging Processes 75
 - Notes Tab 87
 - Placing Your Artwork 72
 - Presetting Your Cut Lines 71
 - Process Settings 70
 - Saving Your Settings 80
 - Sending Your First Project 63
 - Setting Up CorelDRAW 62
- Dashboard Tab 57
- Database Tab 58
- Display 89
- Display Tab 57
- Door Interlocks
 - Interlock Safety 9
- Driver Compatibility 62
- Driver Update 58
- Driver Updates 26

E

- Electrical Requirements 19, 131
 - Electrical Power 15, 19
- Electrical Safety 8
- Emergency Stop 105
- Engraving Direction
 - Bottom-Top 82
- Epilog Job Manager 39
 - Installation 27
 - Instructions 27
- Ethernet 15, 19
 - Ethernet Installation 35
- Exhaust 17, 18
 - CFM 17
 - Exhaust Port 18
- Exhaust Fan 17
 - Blower Switch 17
 - Connection 17

F

- Finding Job History 47
- Fire Warning 1, 9

INDEX

Firmware 121
Focus function 90
Focus Menu 96
Frequency 83

G

Go/Stop Button 89. *See also* LED Status
Group / Ungroup 72
Guidelines 83

H

Halotron Extinguisher. *See* Fire Extinguisher
Home Axis 93
Home Table 93
Homing 89

I

Idle 89
IEC 60825-1 9
Interlock Safety 9
IP Address 22, 23, 93
IRIS Camera Positioning System 103
 Using the IRIS Camera 103

J

Job Folders 43
Job Manager 39, 81, 93
 Changing Program Settings 57
 Finding Job History 47
 How to Install the Epilog Job Manager 29
 Job Settings Tab 53
 Material Settings 55
 Previewing Your Job 46
 Searching for a Job 47
 Troubleshooting the Job Manager 37
 Using the Epilog Job Manager 39
Job Menu 91
Job Storage 97
Jog function 91
Jogging 89
Jog Menu 95
Joystick 97

L

Laserable Plastics
 Suppliers 137, 142
Laser Dashboard
 Settings and Use 61–88
Laser Safety 7
Laser System Classification 131

LED Status 90
Locking Coordinates 95

M

Manual Focus 69, 104, 105
Match Orientation and Size 42
Material Settings 137, 142
Maximum Engraving Area 131
Max Material Thickness 131
Memory 97
Memory Buffer 131
Merge Processes 70
Metal Etching 127
Metal Etching Techniques 127
Motion Control System 131
Multiple Pages 88
Multiple Passes 88

N

Network Settings 93
Notes Tab 87
Nudge 95
 Nudge arrows 95

O

Offset 70, 83
Operating Modes 131
Operating Temperature 16
OSHA 8

P

Park Axis 93, 95
Parking 89
Photo Engraving 99
Plastic Marking 128
Plated Metals 139, 144
Pointer Button 91
Polyvinyl Chloride. *See* PVC
Powder Coating 140, 145
Power 131
 Connection 19
 Laser Dashboard 82
Power Connection 19
Power Label 10
Previewing Your Job 46
Print History 47
Print Interface 131
Print Page Orientation 42
Print Range 88
Process Name 70
Process Type 70

INDEX

Program Settings 57
PVC 13

R

Raster Engraving 99
Red Dot Pointer 9, 105
Regulatory Compliance 9–14
Reset Key 90
Resolution 100, 131
Rim-Drive Rotary Attachment 111

S

Safety Enclosure 9
Safety Features 9–14
Safety Labels. *See* Warning Labels
Saving Your Settings 77
Serial Number 133
Setting a Vector Cutting Line 99
Settings/Config menu 93
Setup 15, 71
 Choose Where to Locate the System 16
 Connecting Electrical Power 19
 Connecting the Exhaust 17
 Connect the Laser to Your Computer 19
 Driver Updates 26
 Register Your System 26
 Set the Fusion Pro's IP Address 22
 USB Connection 19
Software Installation 15, 27
Software Suite. *See also* Job Manager
Speed and Power Control 131
Split by Color 57, 71
Split by Hairline 73
Split by Selection 74
Stainless Steel 138, 143
 Annealing 138, 143
Standard Features 131
Storage 97
System Settings 93

T

Technical Specifications 131
Technical Support 133
Temperature 16
Test your material 140, 145
Thickness 70
Titanium 138, 143
Touchscreen. *See* Control Panel
Trace function 91

U

Uncategorized folder 43
Upgrading Firmware 121
USB
 Connecting the Laser 19
 USB Installation 37

V

Vector Cutting 99
Vector Line Creation 99
Vector Line Width 100
Vector Sorting
 Inside/Out 49
 Optimized 49
Ventilation 131
Vinyl 13

W

Warning Labels 9
Warranty 135
Wattages 131
Weight 131
Windows 7
 Ethernet Installation 35

